

015000500

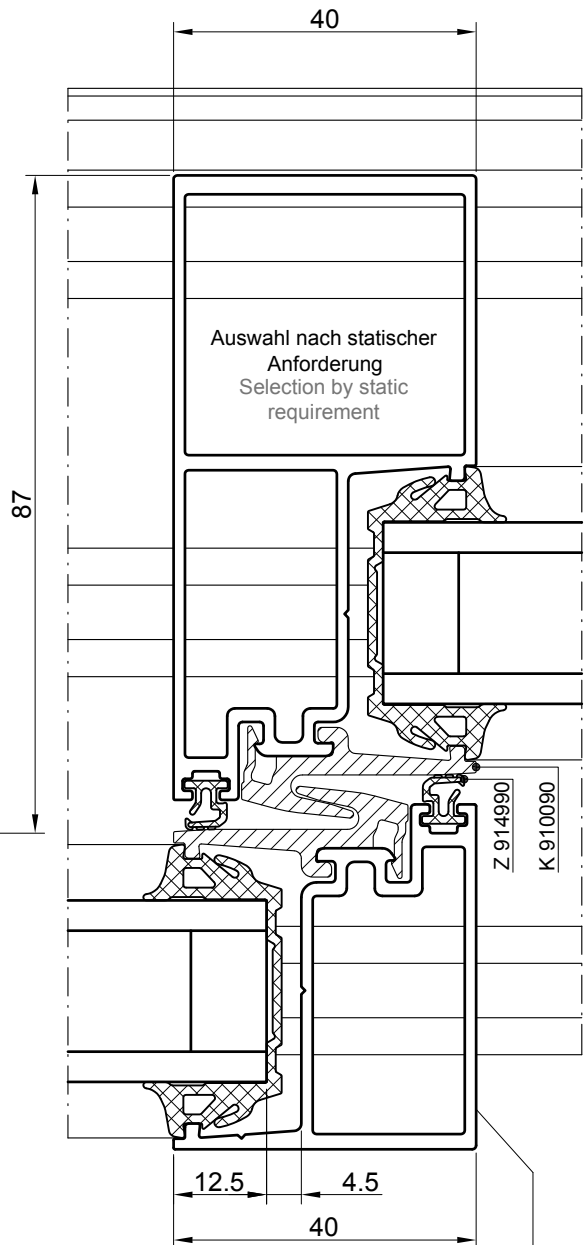
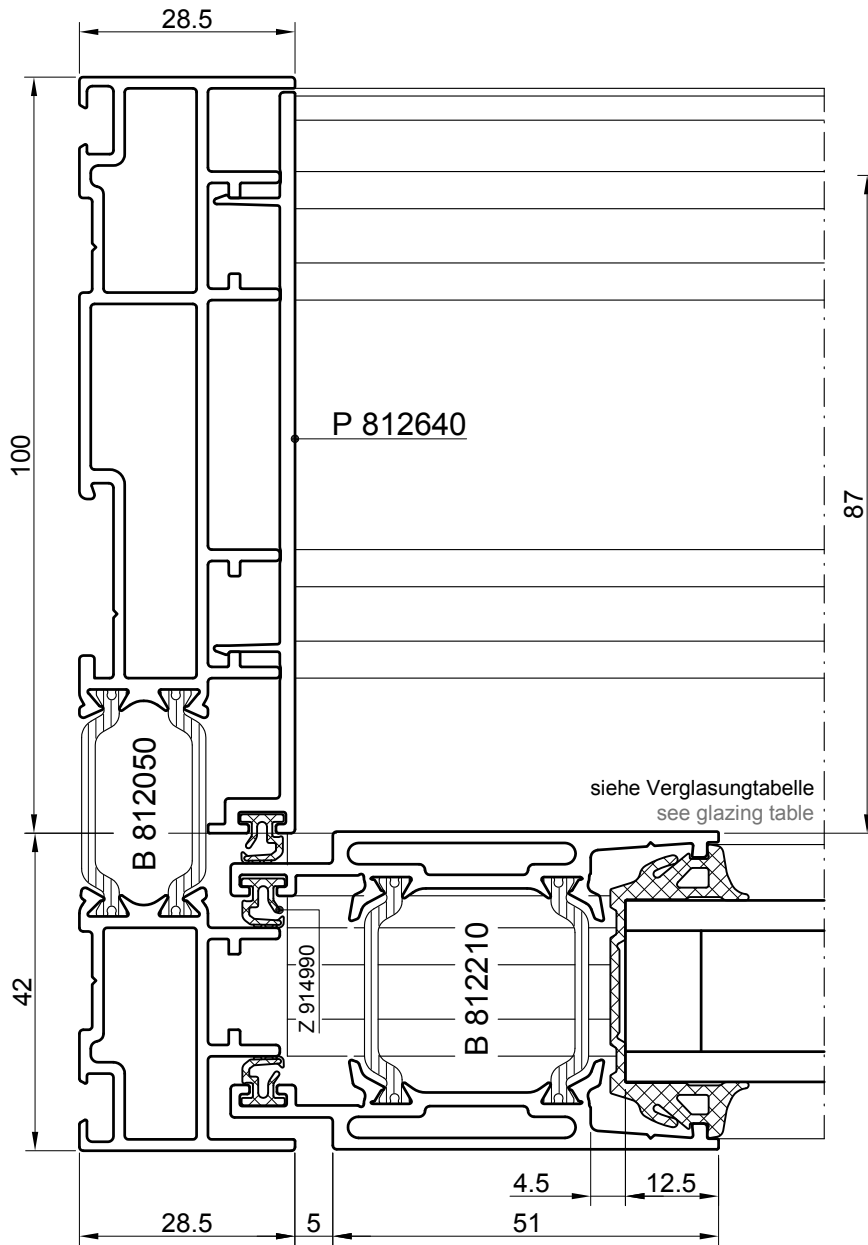
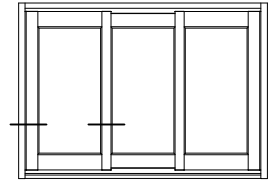

Berechnung der Glasabmessungen
siehe Tab. Verglasung, Seite 14

Calculation of glass dimensions
see tab glazing, page 14

Auswahl nach statischer
Anforderung
Selection by static
requirement

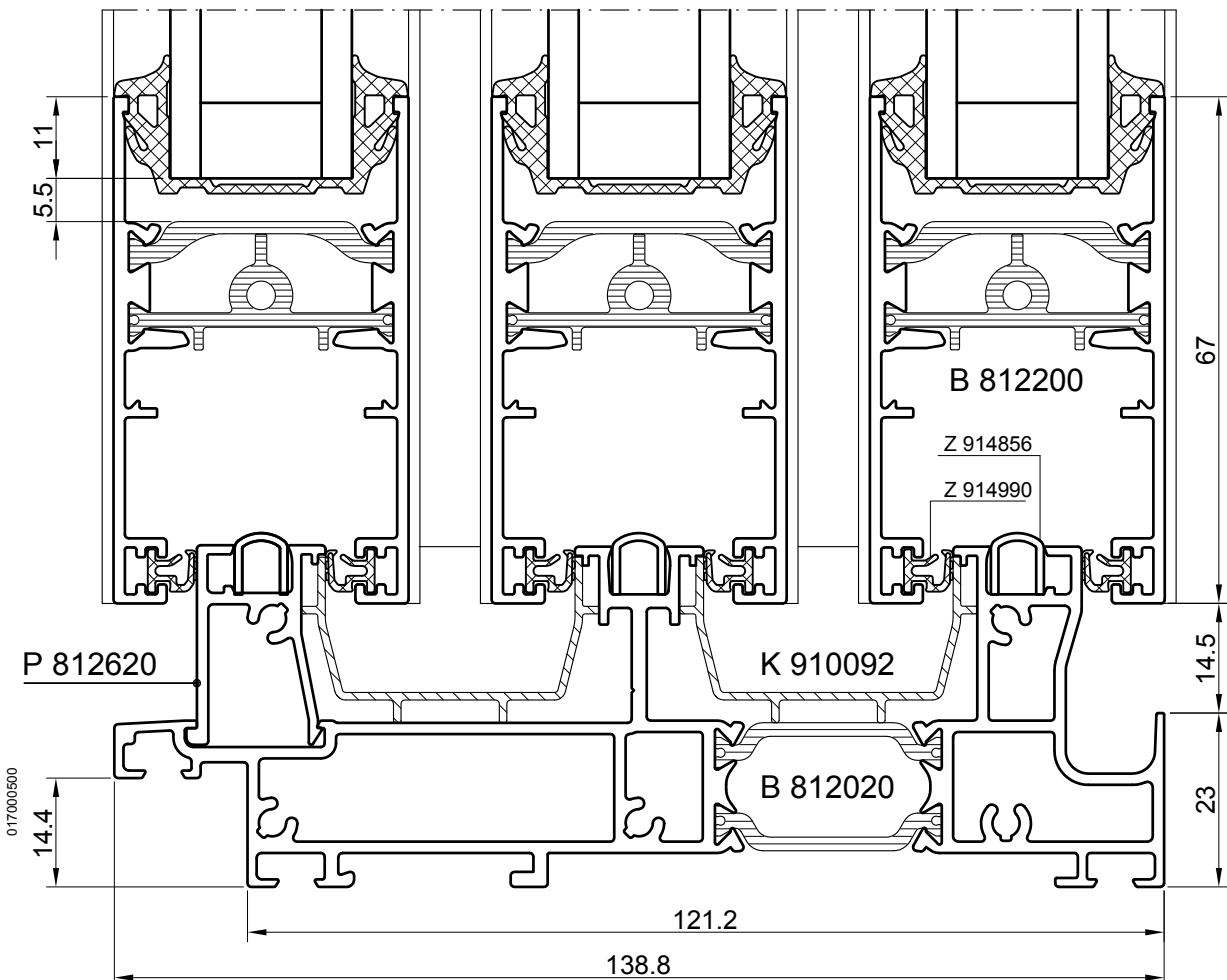
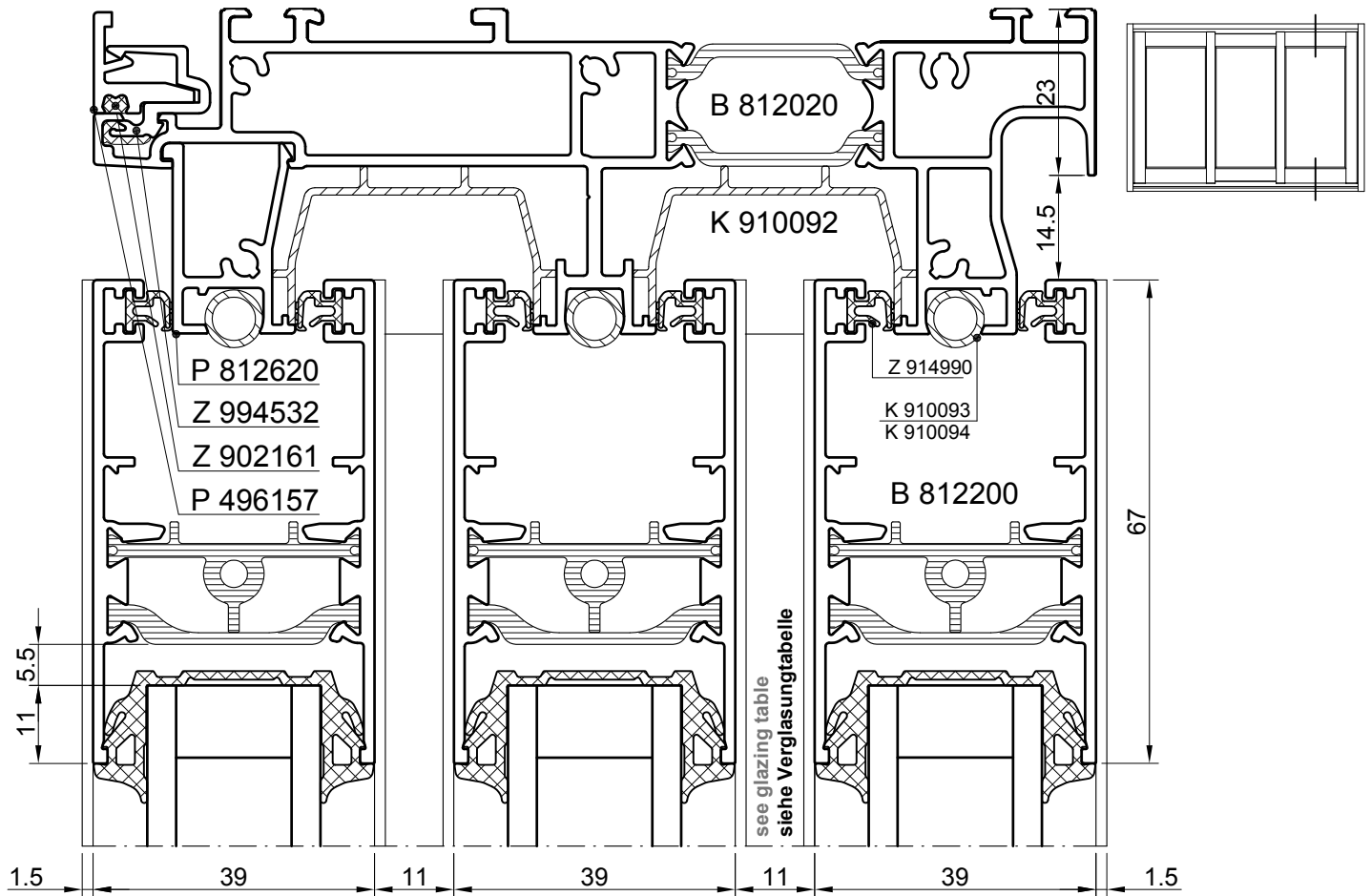

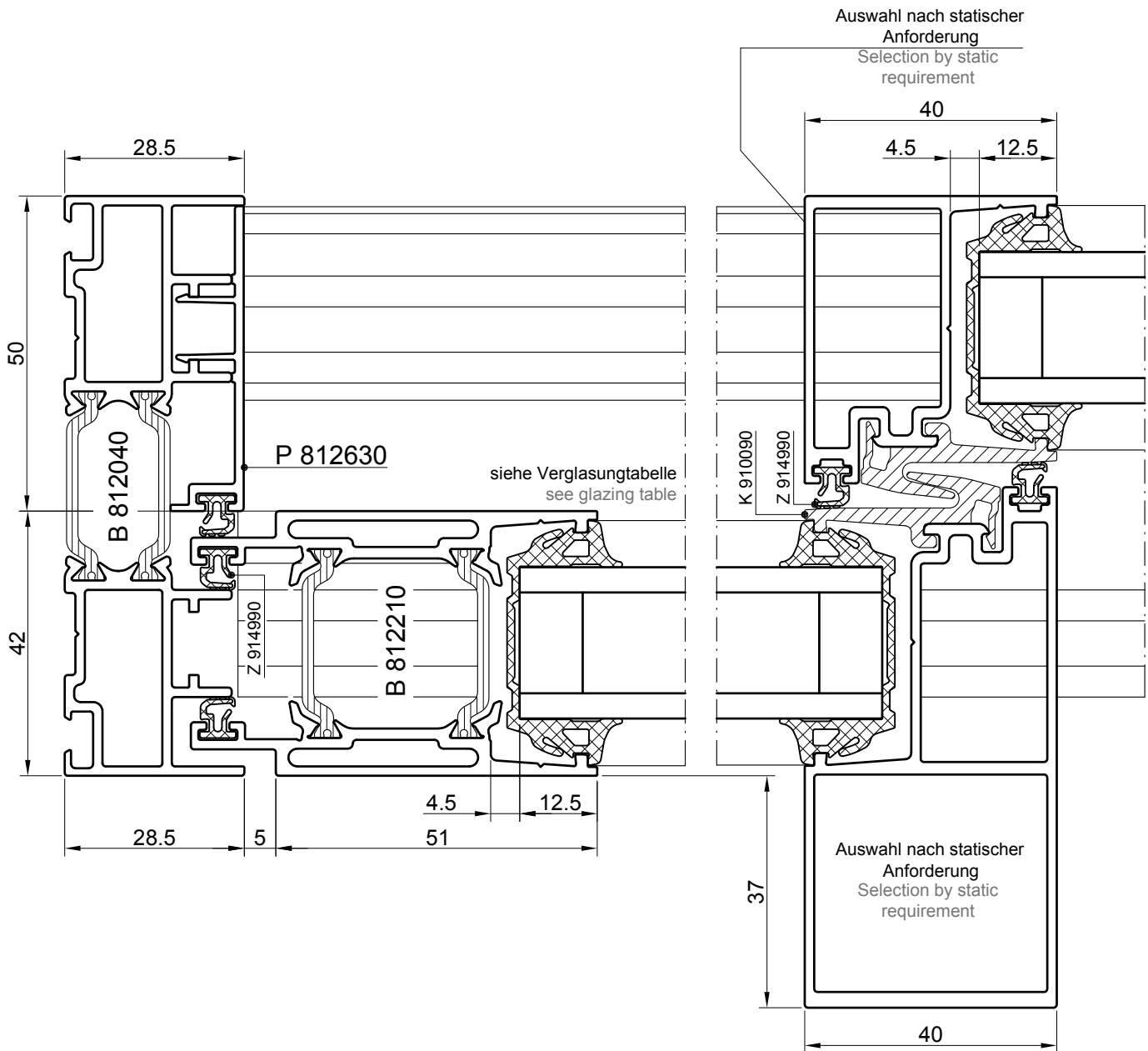
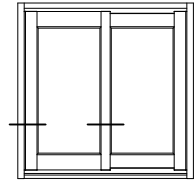

Berechnung der Glasabmessungen
siehe Tab. Verglasung, Seite 14

Calculation of glass dimensions
see tab glazing, page 14

- Z 994532
- P 496158
- Z 902161
- P 812620

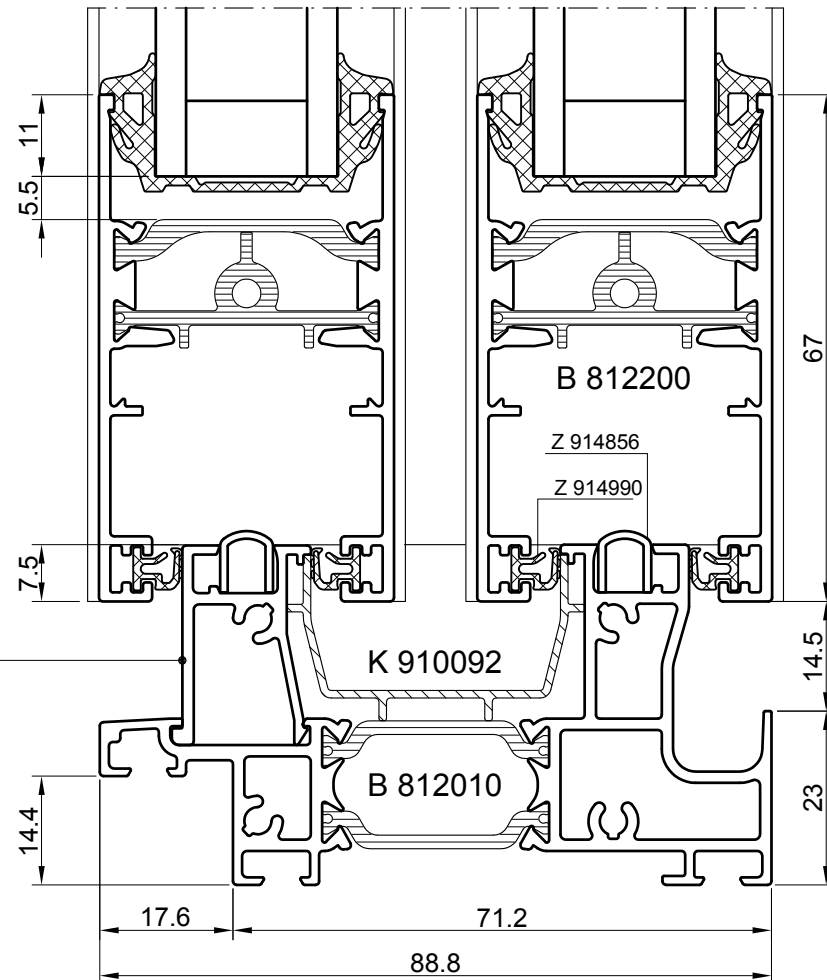
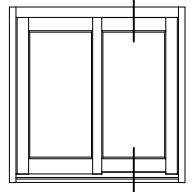
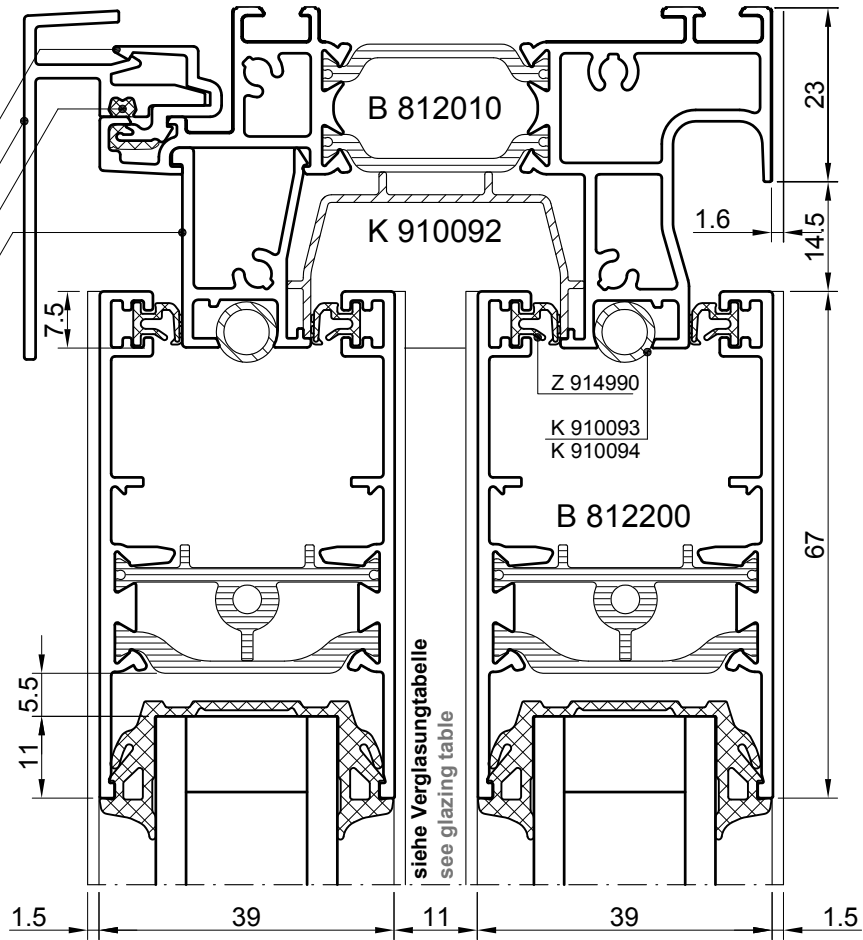

P 812620

019000500

Koppelung mit Lambda 77L
Coupling with Lambda 77L

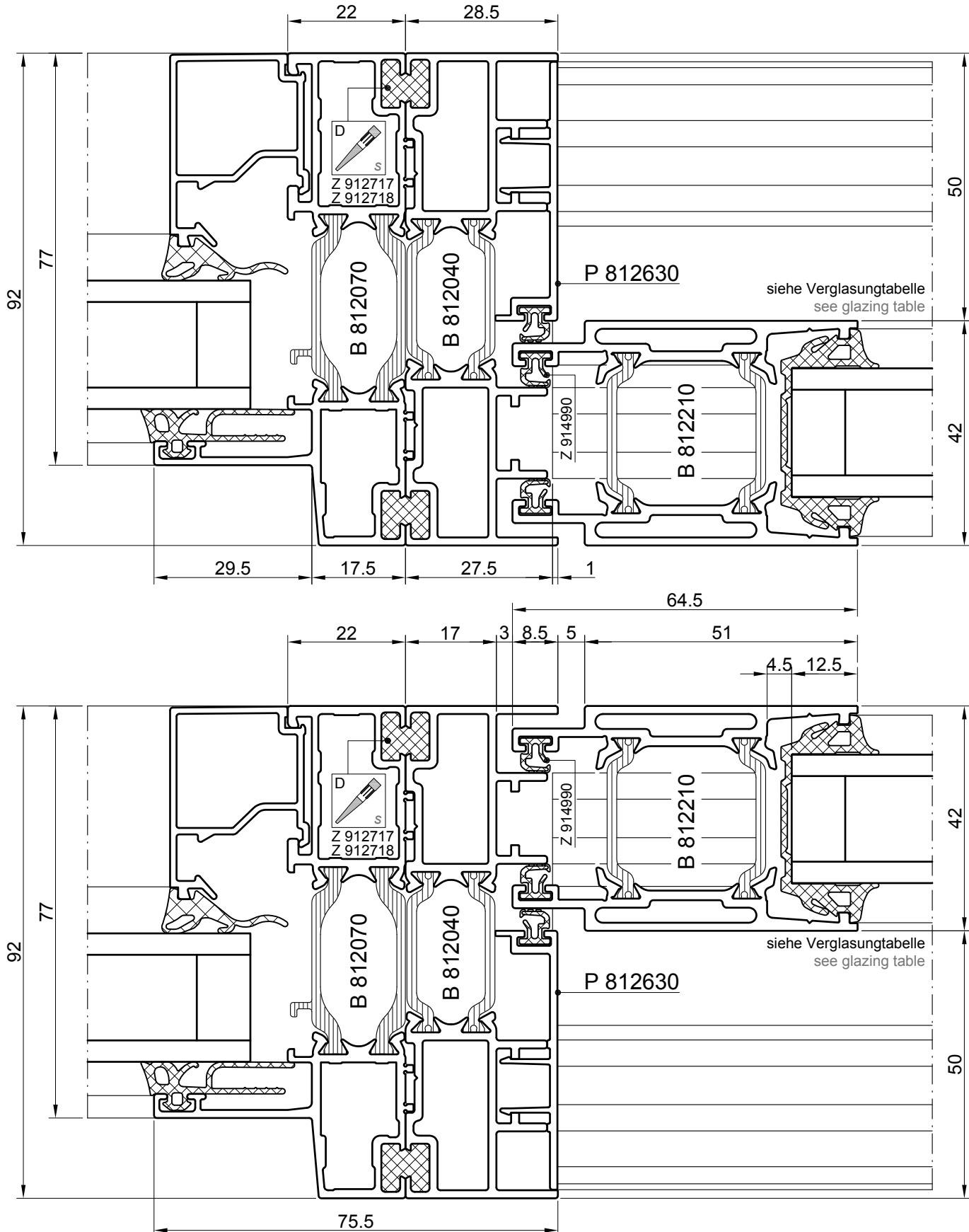
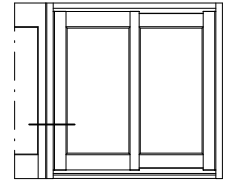

Koppelung mit Lambda 77L
Coupling with Lambda 77L

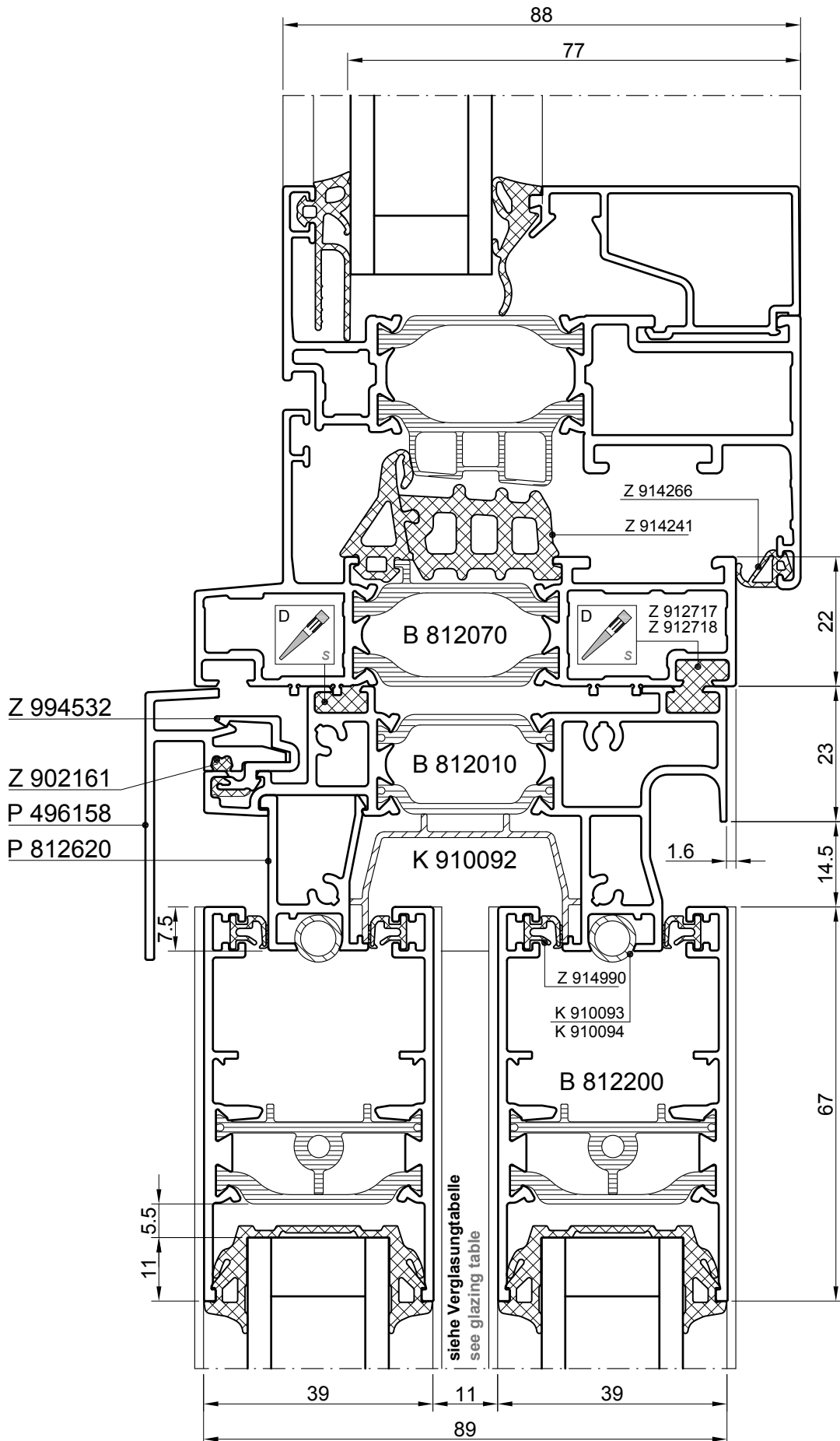
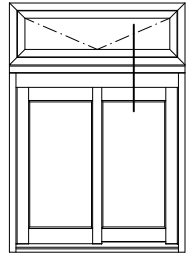

021000500

Koppelung mit Lambda 65M
Coupling with Lambda 65M

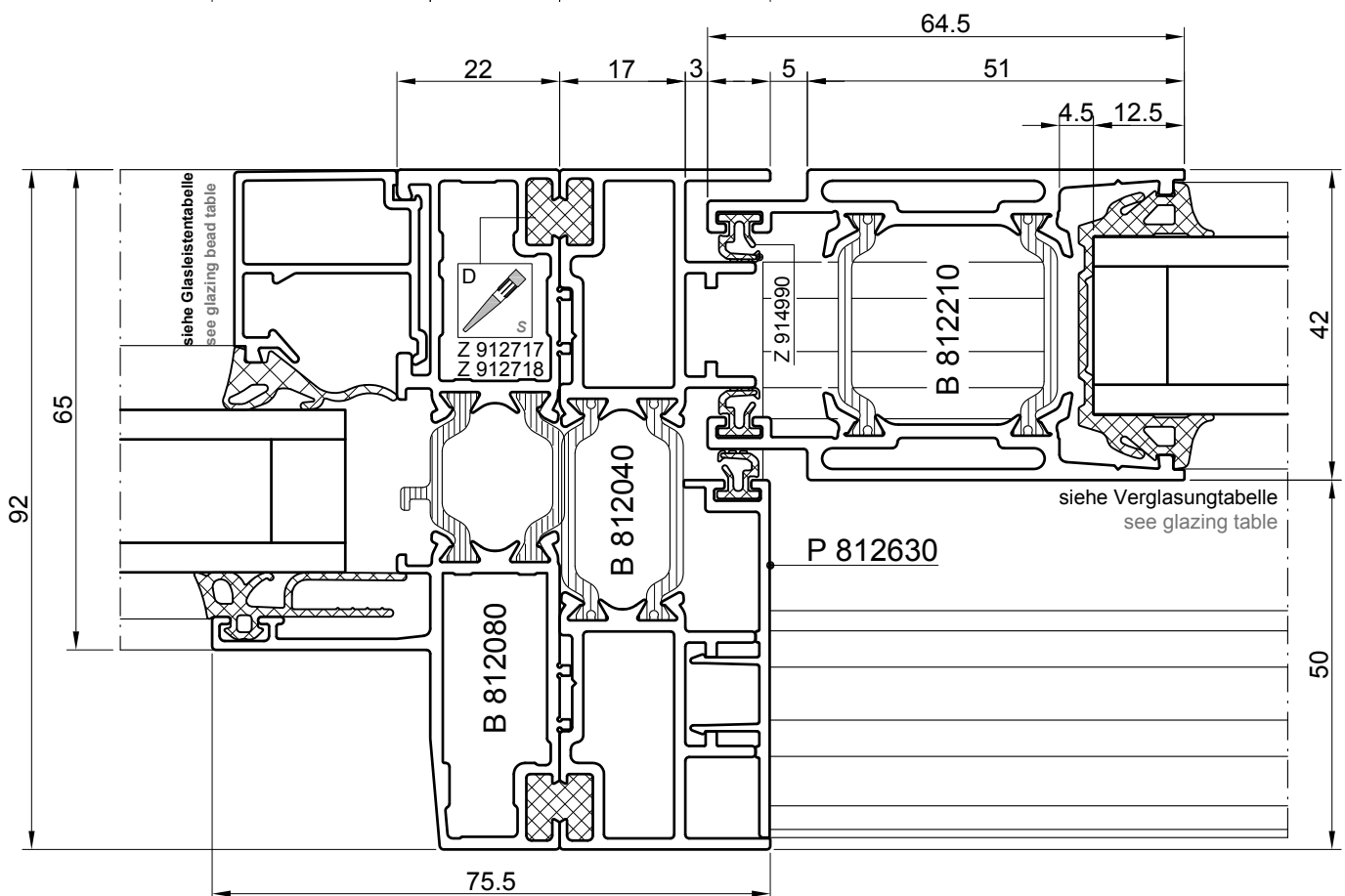
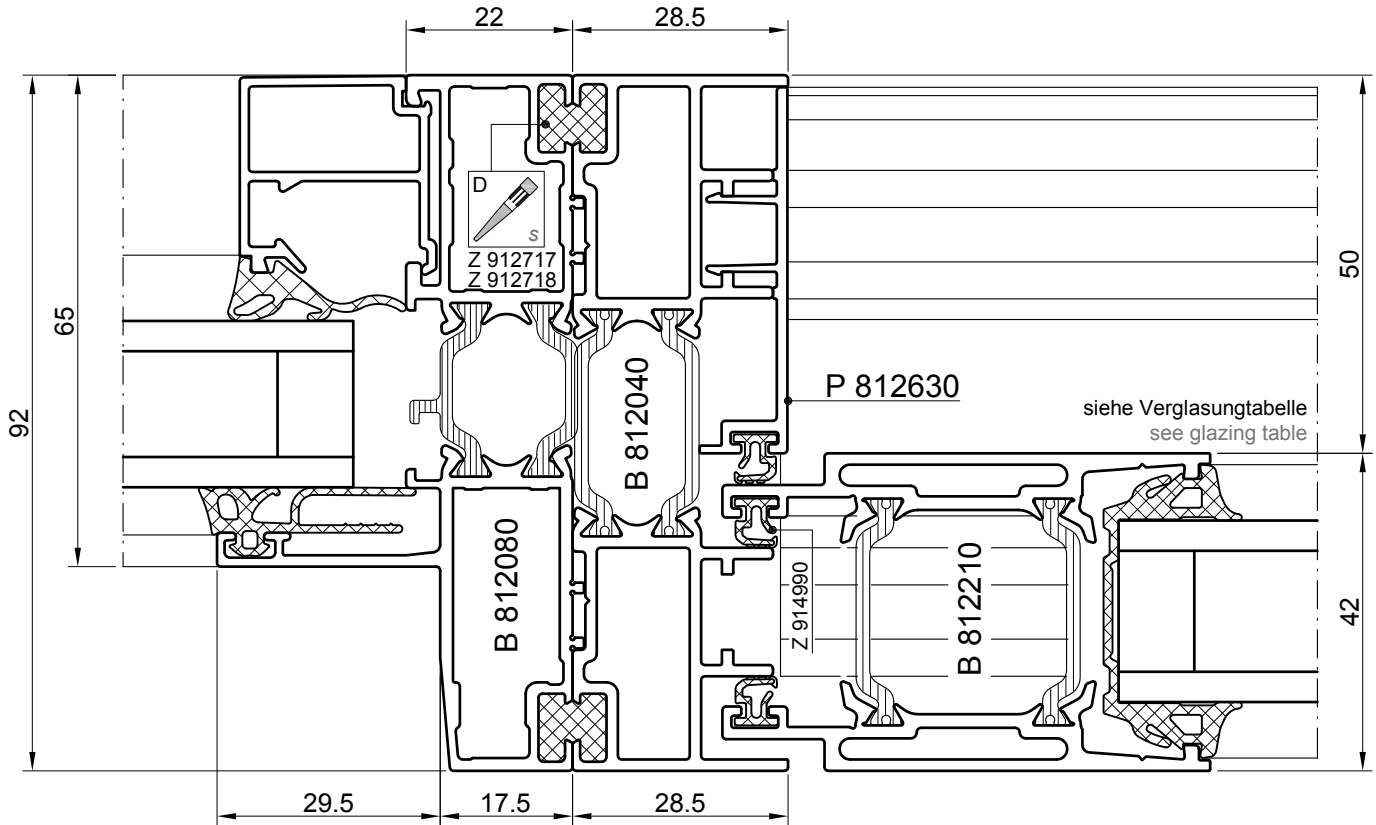
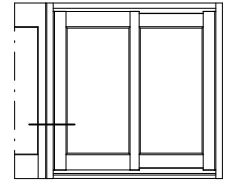

022000500

Koppelung mit Lambda 65M
Coupling with Lambda 65M

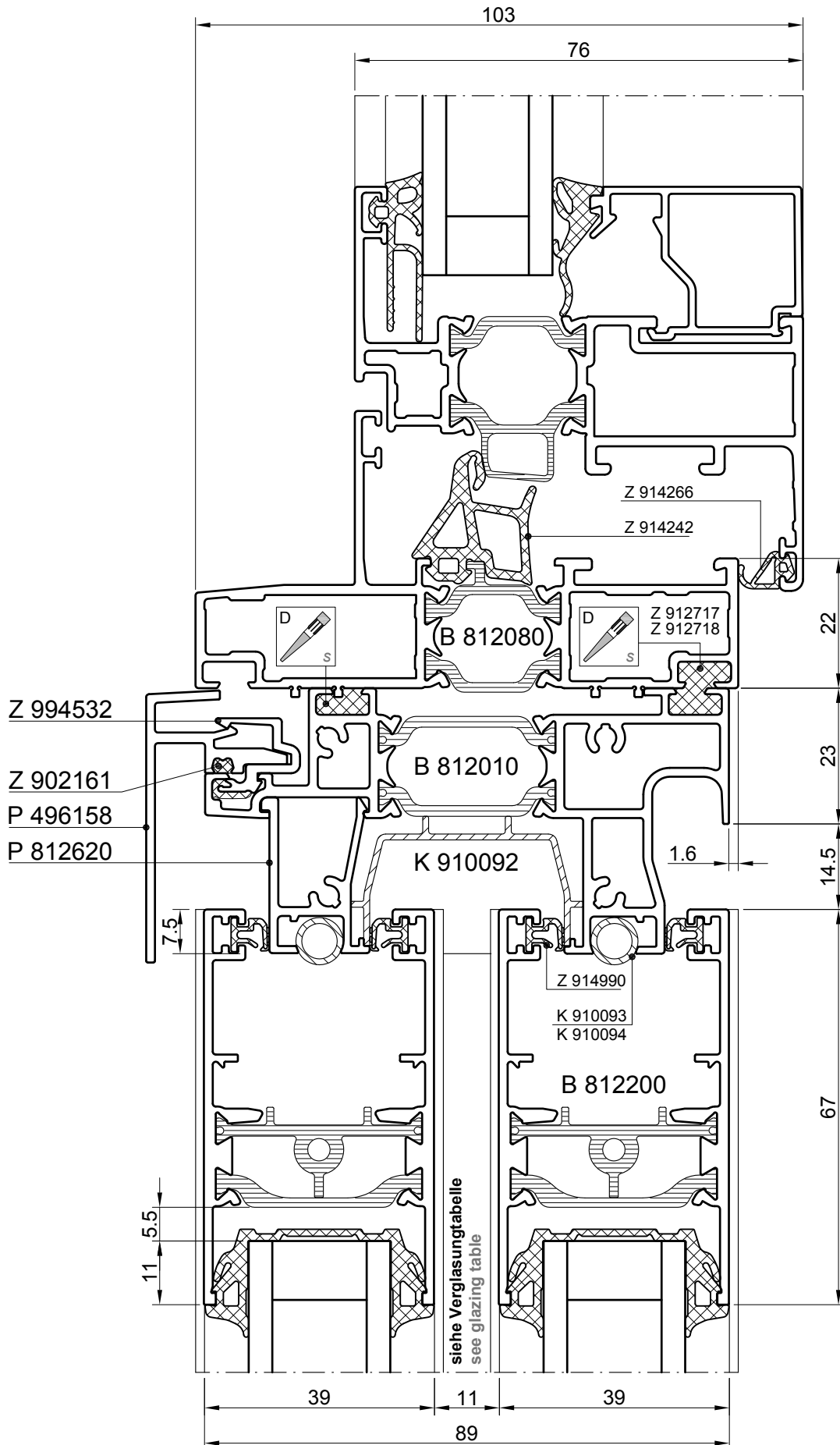
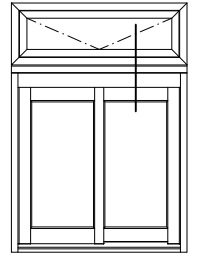

023000500

Koppelung mit Lambda 77L
Coupling with Lambda 77L

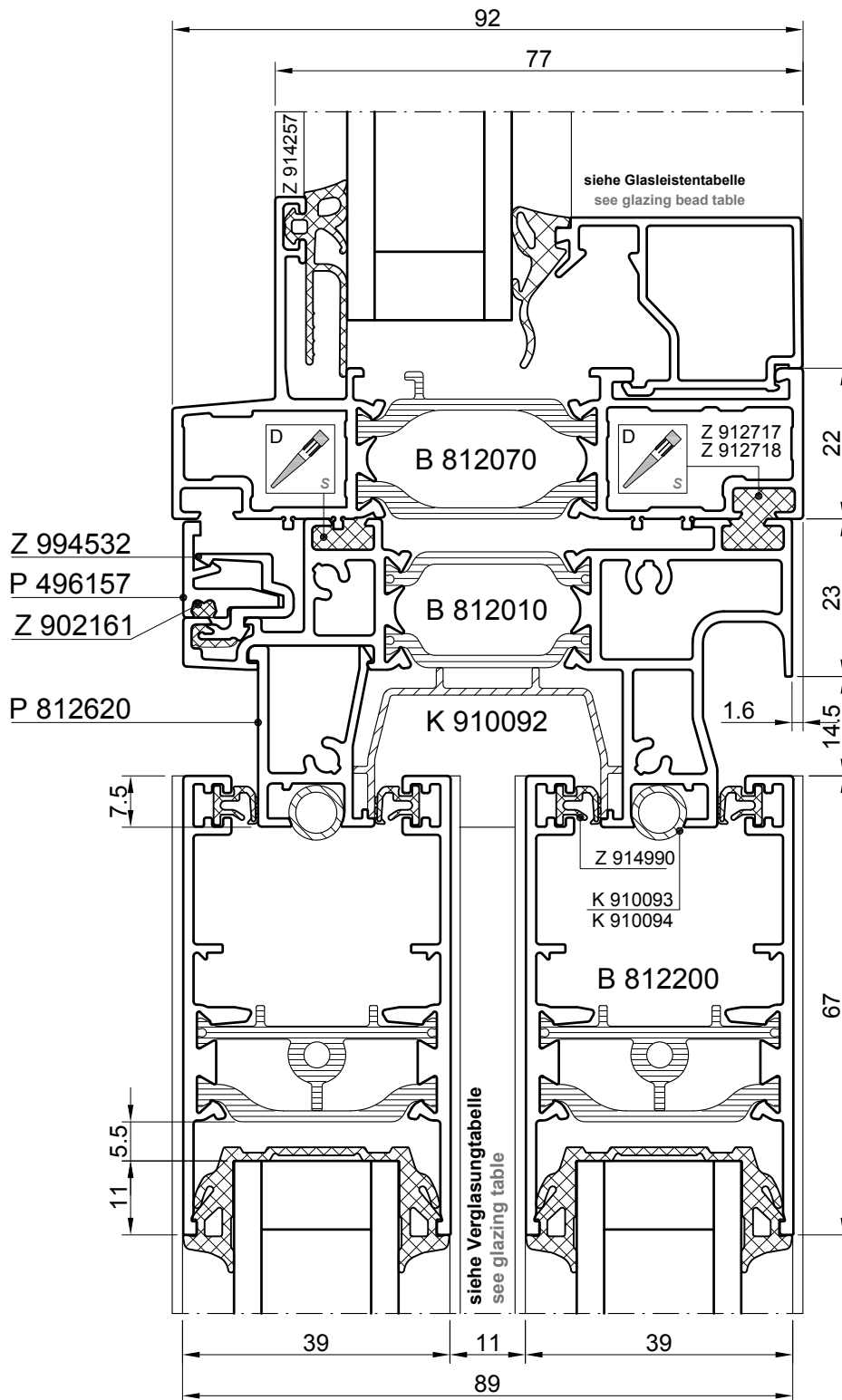
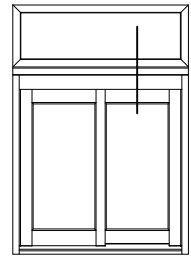

024000500

Koppelung mit Lambda 65M
Coupling with Lambda 65M

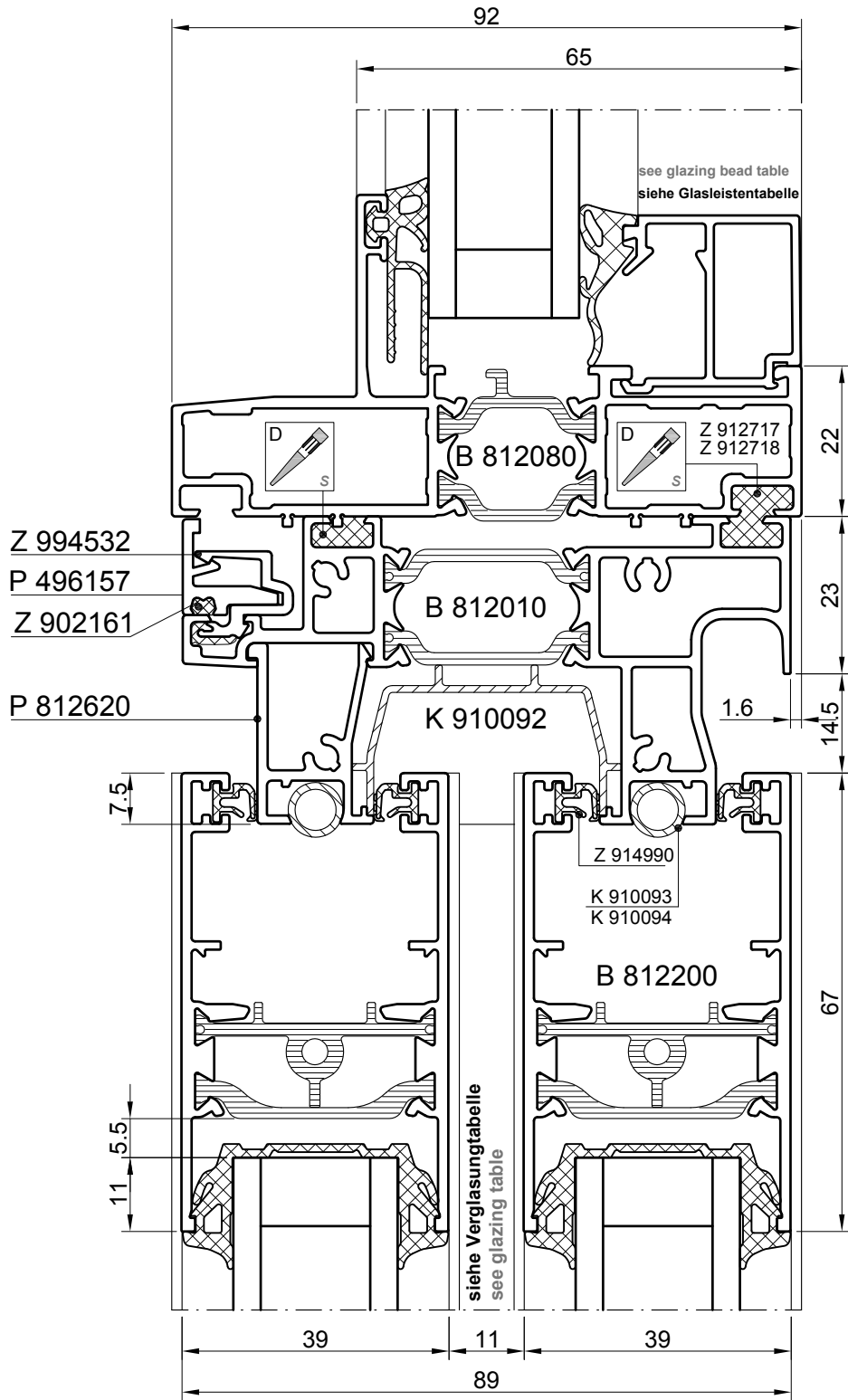
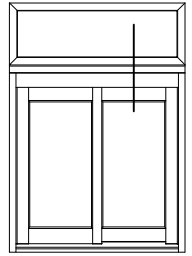

025000500

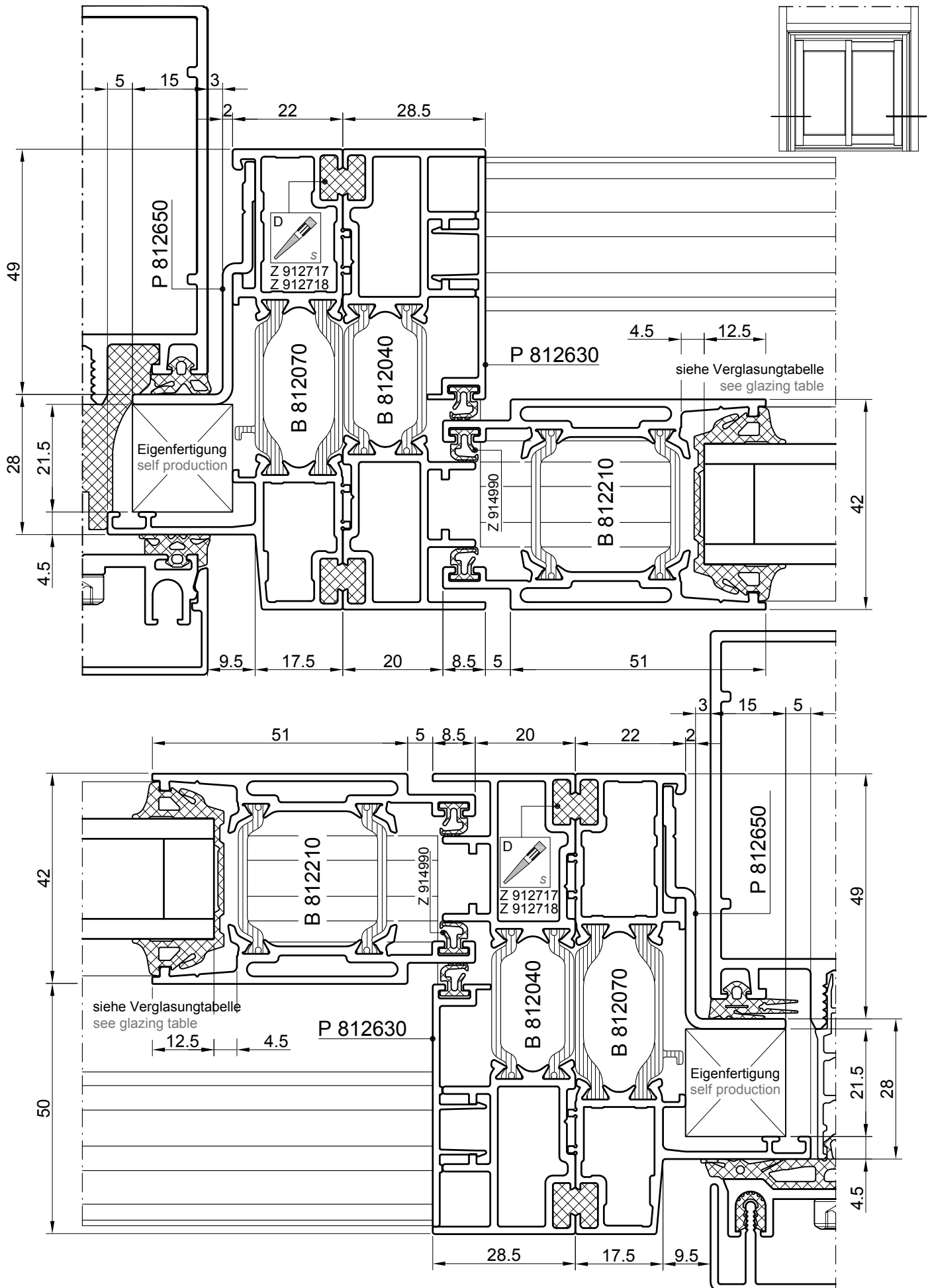

026000500

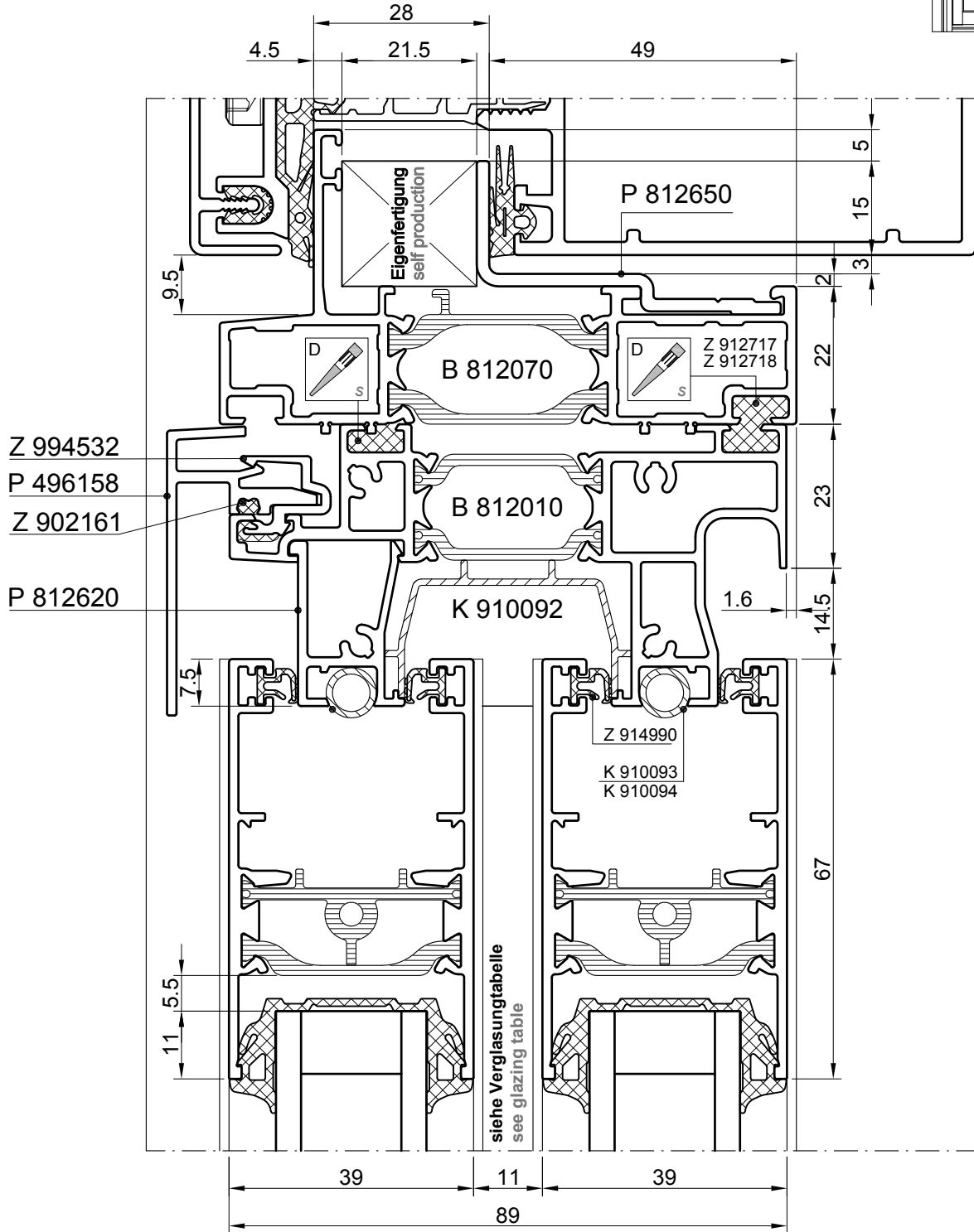
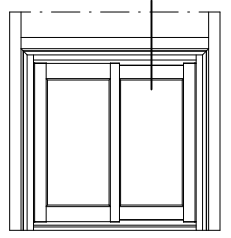

027000500