

Beschläge

Fittings

Volato S - Schiebekonstruktion
Volato S - Sliding construction

Inhaltsübersicht - Beschläge
Contents - Fittings

Seite
Page

Inhaltsübersicht
Contents

2

Profilzylinder, Laufwagen
Profile cylinder, tandem roller

3

Griffe
Handles

4 - 5

Riegel - Sicherheitsverschlüsse
Bolt safety locks

6 - 7

Anschlagpuffer
Stop buffer

7

002000500

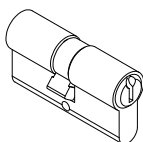

Z 900037

Profilzylinder 30 mm / 30 mm
mit 3 Schlüsseln

Z 900037

Profile cylinder 30 mm / 30 mm
with 3 keys

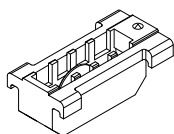

Z 914826

Laufwagen, fest, mit Einfachrolle,
max. Tragfähigkeit 75 kg

Z 914826

Tandem roller, fixed, with single roll,
max. bearing capacity 75 kg

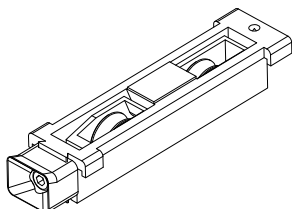

Z 914827

Laufwagen, stufenlos verstellbar, mit
Doppelrolle, max. Tragfähigkeit 100 kg

Z 914827

Tandem roller, fully adjustable, with double roll,
max. bearing capacity 100 kg

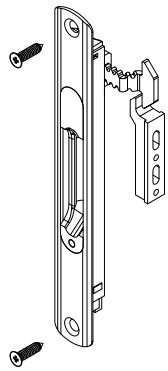

Z 914822 02
Z 914822 64

Verschluss für Muschelgriff,
bestehend aus:
Muschelgriff, Schließhaken, Verschlussplatte
und Befestigungsschrauben

Z 914822 02
Z 914822 64

lock for lockable inset,
consisting of:
lockable inset, locking hook, locking plate
and fixing screws

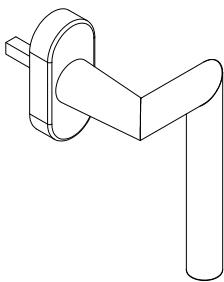

Z 914884 31

Fenstergriff gekröpft **DIN R**,
Befestigungsschrauben **Z 907288** M5 x 35 mm
bitte separat bestellen

Z 914884 31

Windows handle cranked **DIN R**,
please order the fixing screws **Z 907288**
M5 x 35 separately

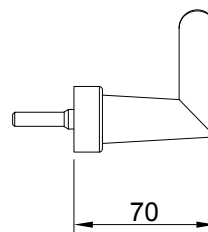
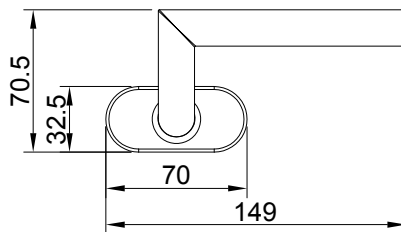

Bei beidseitiger Griffmontage, bitte Drückerstift
Z 917706 □ 7 x 85 mm separat bestellen

If using handles on both sides, please order the
square pin **Z 917706** □ 7 x 85 mm separately

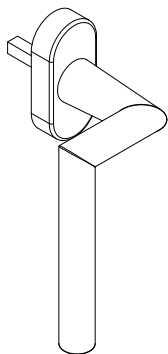

Z 914885 31

Fenstergriff gekröpft **DIN L**,
Befestigungsschrauben **Z 907288** M5 x 35 mm
bitte separat bestellen

Z 914885 31

Windows handle cranked **DIN L**,
please order the fixing screws **Z 907288**
M5 x 35 separately

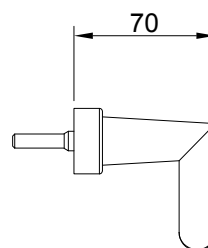
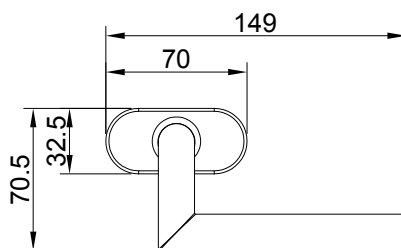

Bei beidseitiger Griffmontage, bitte Drückerstift
Z 917706 □ 7 x 85 mm separat bestellen

If using handles on both sides, please order the
square pin **Z 917706** □ 7 x 85 mm separately

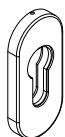

Z 917028 31

Profilzylinder Rosette 9 mm oval

Z 917028 31

Profile cylinder rosette 9 mm oval

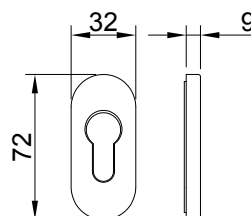
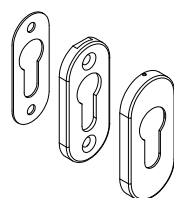

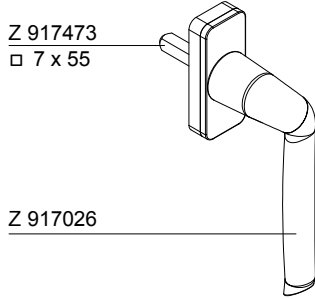

Z 996413 02
Z 996413 64

Fenstergriff gekröpft **DIN R**
 mit Kunststoff- Rosette,
 Befestigungsschrauben **Z 907288** M5 x 35 mm
 bitte separat bestellen

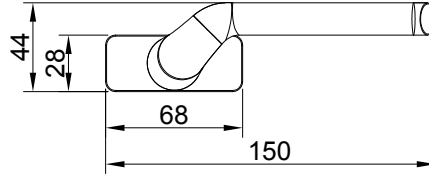

Bei beidseitiger Griffmontage, bitte Drückerstift
 Z 917706 □ 7 x 85 mm separat bestellen

Z 996413 02
Z 996413 64

Windows handle cranked **DIN R**
 with synthetic rosette,
 please order the fixing screws **Z 907288**
 M5 x 35 separately

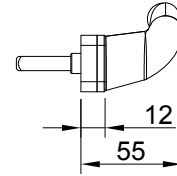

If using handles on both sides, please order the
 square pin **Z 917706** □ 7 x 85 mm separately

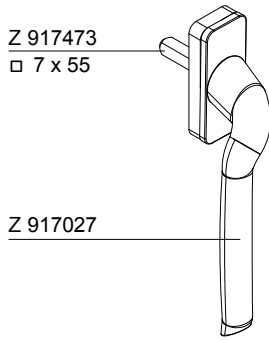

Z 996414 02
Z 996414 64

Fenstergriff gekröpft **DIN L**
 mit Kunststoff- Rosette,
 Befestigungsschrauben **Z 907288** M5 x 35 mm
 bitte separat bestellen

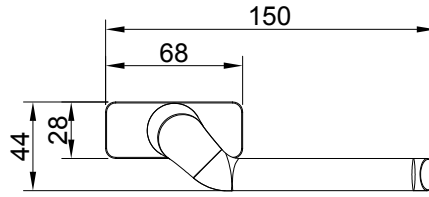

Bei beidseitiger Griffmontage, bitte Drückerstift
 Z 917706 □ 7 x 85 mm separat bestellen

Z 996414 02
Z 996414 64

Windows cranked **DIN L**
 with synthetic rosette,
 please order the fixing screws **Z 907288**
 M5 x 35 separately

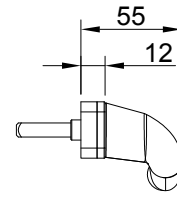

If using handles on both sides, please order the
 square pin **Z 917706** □ 7 x 85 mm separately

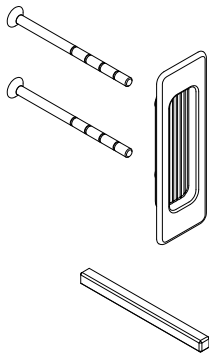

Z 917492 02
Z 917492 64

Muschelgriff,
 incl. Befestigungsschrauben

Z 917706

Drückerstift,
 für beidseitige Griffmontage, □ 7 x 85 mm

Z 917492 02
Z 917492 64

Lockable inset,
 with fixing screws

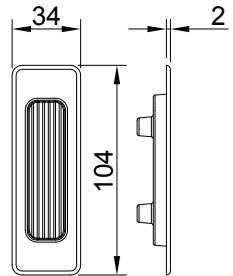

Z 917706

square pin,
 when using handles on both sides, □ 7 x 85 mm

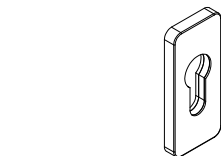

Z 994067 02
Z 994067 64

Profilzylinder Rosette 9 mm,
 incl. Befestigungsschrauben

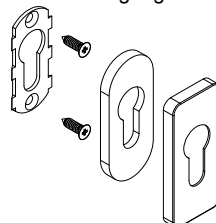

Z 994067 02
Z 994067 64

Profile cylinder rosette 9 mm,
 with fixing screws

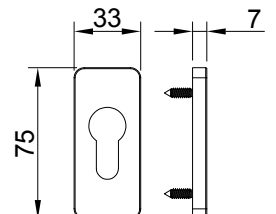

005000501

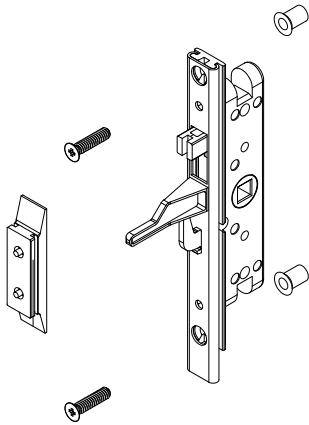

Z 996250

Riegel - Sicherheitsverschluss SR3100
mit Schwenkriegel, 7 mm Drückernuss,
Dornmaß 12.5 mm

Bitte Hinterlage Z 917707 1x pro Schloss
separat bestellen

Z 996250

Bolt safety lock SR 3300
with swing locking, 7 mm square pin, 12.5 mm
backset

Please order the base plate Z 917707 1x per
lock separately

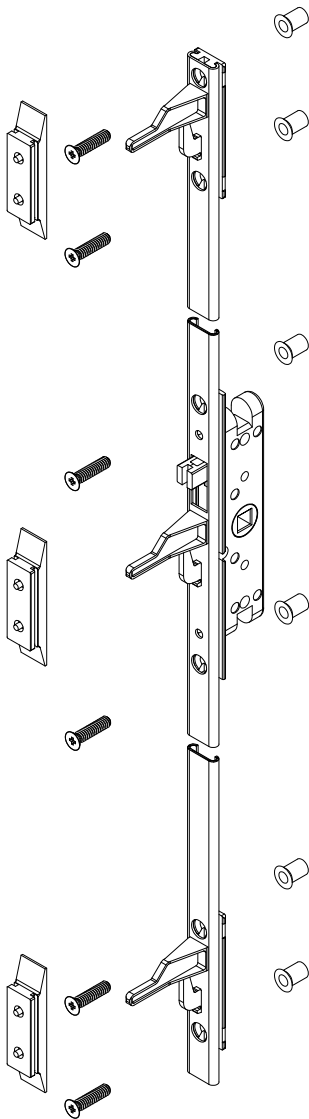

Z 996251

Drei-Riegel-Sicherheitsverschluss SR 3300
mit Schwenkriegel, 7 mm Drückernuss,
Dornmaß 12.5 mm

Bitte Hinterlage Z 917707 1x pro Schloss
separat bestellen

Z 996251

Three-bolt safety lock SR 3300
with swing locking, 7 mm square pin, 12.5 mm
backset

Please order the base plate Z 917707 1x per
lock separately

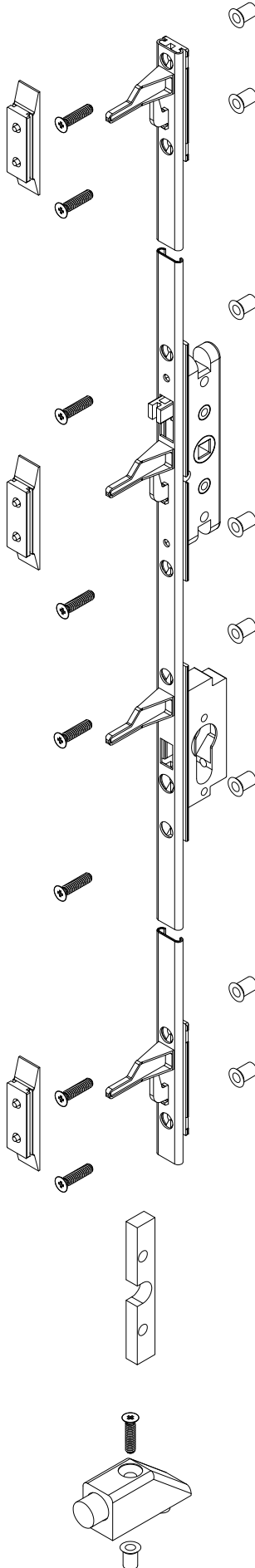

Z 996252

Drei-Riegel-Sicherheitsverschluss SR 3300 i
Vorgerichtet für Profilzylinder mit Schwenkriegel,
7 mm Drückernuß, Dornmass 12.5 mm

Bitte Hinterlage Z 917707 1x pro Schloss
separat bestellen

Z 996252

Three-bolt safety lock SR 3300 i
prepared for profile cylinder with swing locking,
7 mm square pin, 12.5 mm backset

Please order the base plate Z 917707 1x per
lock separately

Z 917707

Hinterlage,
bitte 1x pro Schloss bestellen

Z 917707

Base plate,
please order 1 per lock

Z 996281 02
Z 996281 64

Anschlagpuffer

Z 996281 02
Z 996281 64

Stop buffer

007000500

