

HUECK

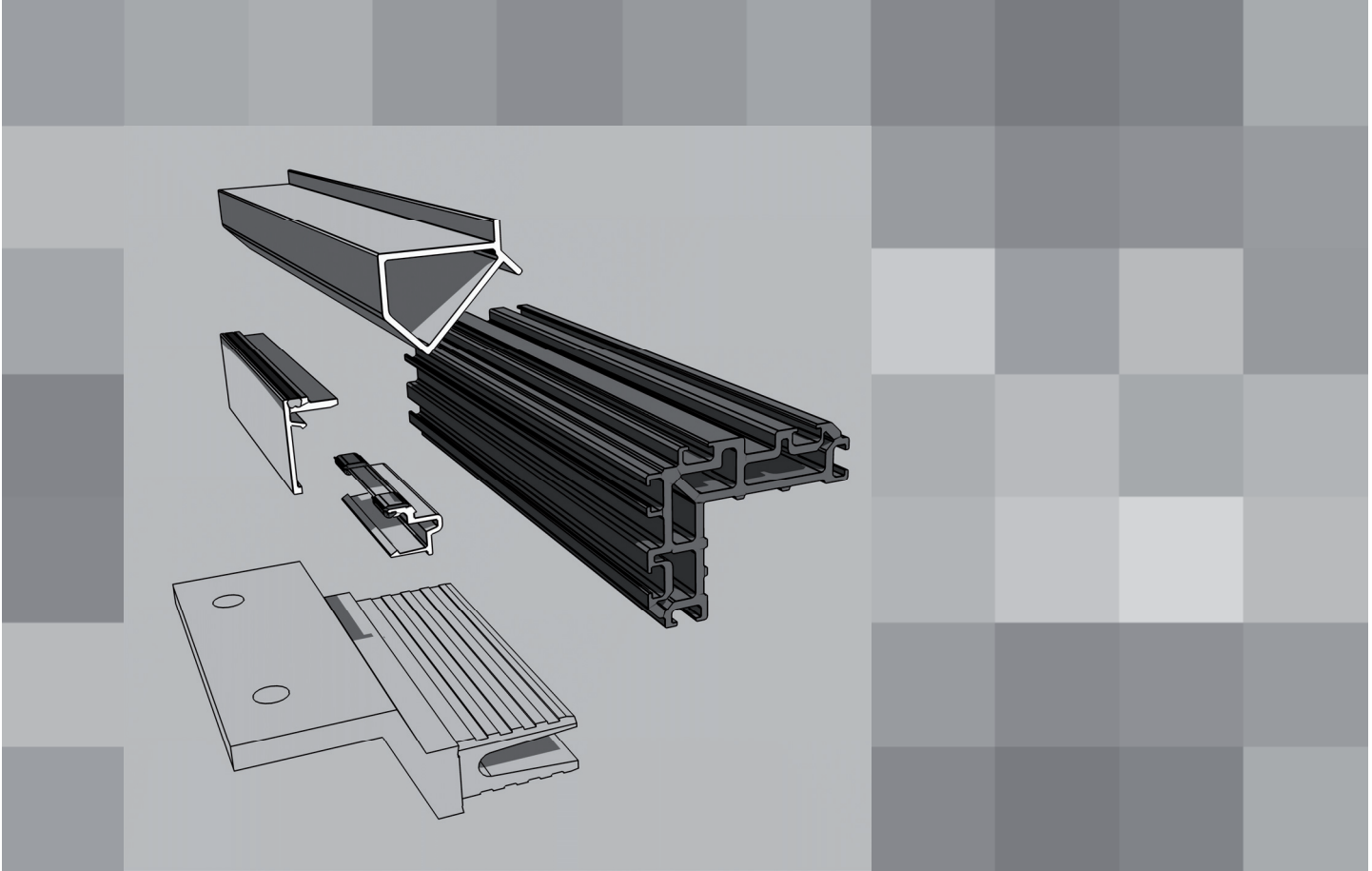

Zusatzprofile

Supplementary profiles

Volato S - Schiebekonstruktion Volato S - Sliding construction

Inhaltsübersicht - Zusatzprofile Contents - Supplementary profiles

Seite
Page

Inhaltsübersicht
Contents

2

Profilübersicht
Profile overview

3







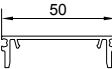
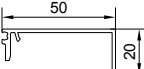
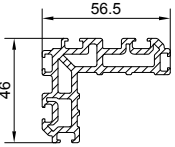

Wandanschlussprofile
Wall connecting profiles

4

Klipsprofile | Allgemeine Zusatzprofile
Snap profiles | General supplementary profiles

5

Profilübersicht - Zusatzprofile Profile overview - Supplementary profiles

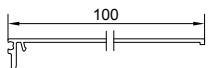
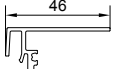
	Profil-Nr. Profile number	Abw. aussen ohne Dämmzone External perimeter excluding insulating zone	Seite Page		Profil-Nr. Profile number	Abw. aussen ohne Dämmzone External perimeter excluding insulating zone	Seite Page		Profil-Nr. Profile number	Abw. aussen ohne Dämmzone External perimeter excluding insulating zone	Seite Page
	P 496114	-	4		P 496153	176	4		K 910083	-	5
	P 496148	57	4		P 496154	111	4				
	P 496149	91	4		P 496155	168	4				
	P 496150	101	4		P 496156	115	4				
	P 496151	121	4		P 496157	68	4				
	P 496152	241	4		P 496158	181	4				

003002100



P 496148

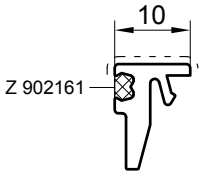

P 496157

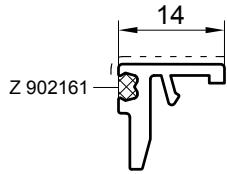

P 496149

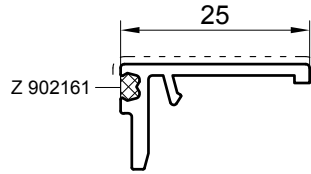

P 496150

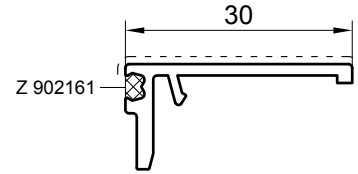

P 496151

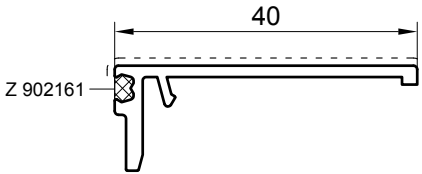

P 496153

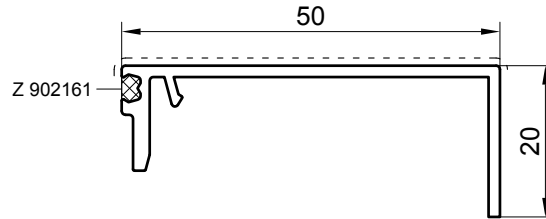

P 496152

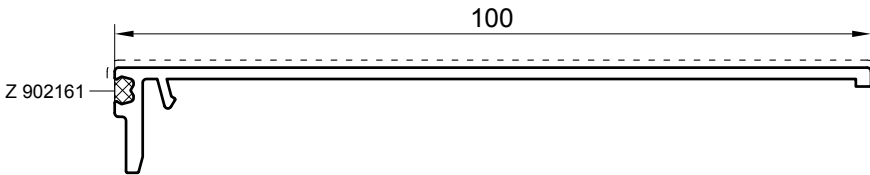

P 496154

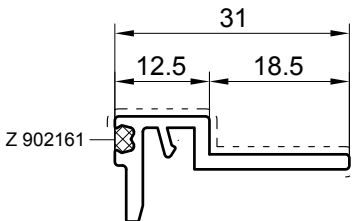

P 496155

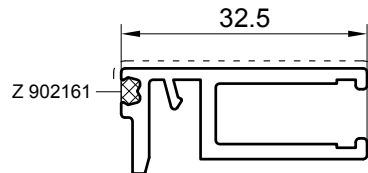

P 496156

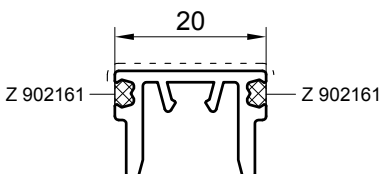

P 496114

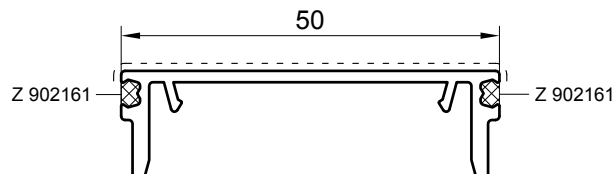

M 1:1
Scale 1:1

Klipsprofile für die Befestigung der Wandanschlussprofile Snap profiles for fixing the wall connecting profiles

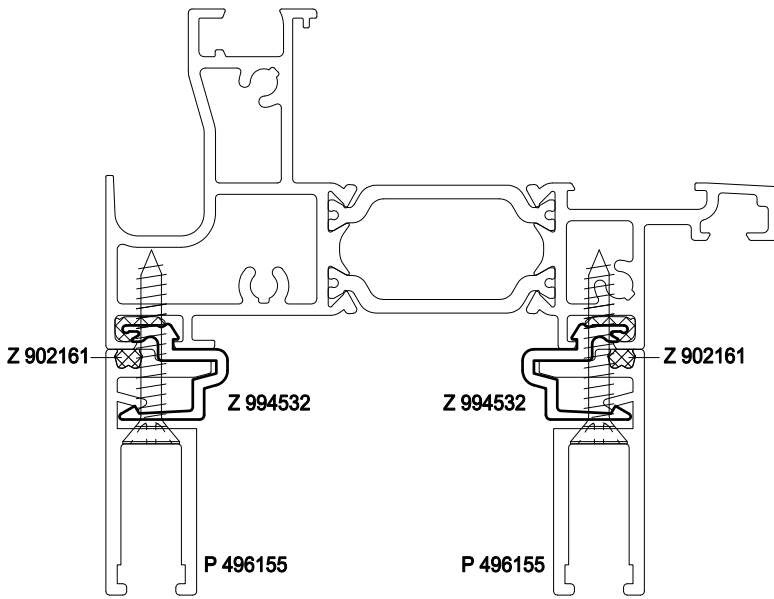

Z 994532

Klipsprofil mit Dichtung
für die Befestigung aussen
L = 50 mm

Z 994532

Snap profile with gasket
for assembly at the outside
L = 50 mm



Optional Profile verschrauben
2x pro Meter

Optional screw the profiles
2x per meter

Allgemeine Zusatzprofile General supplementary profiles

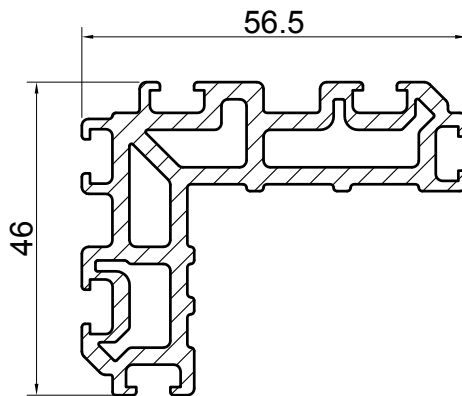

K 910083

Basisprofil

Z 910083

Base profile

Wetterschenkel Weather board profiles

