

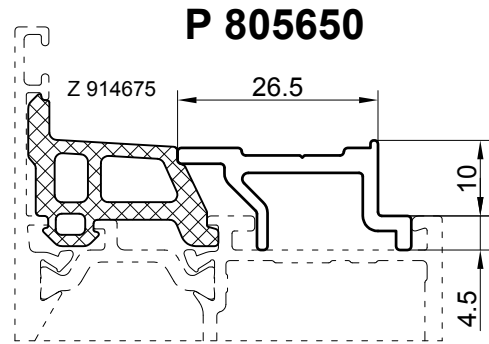

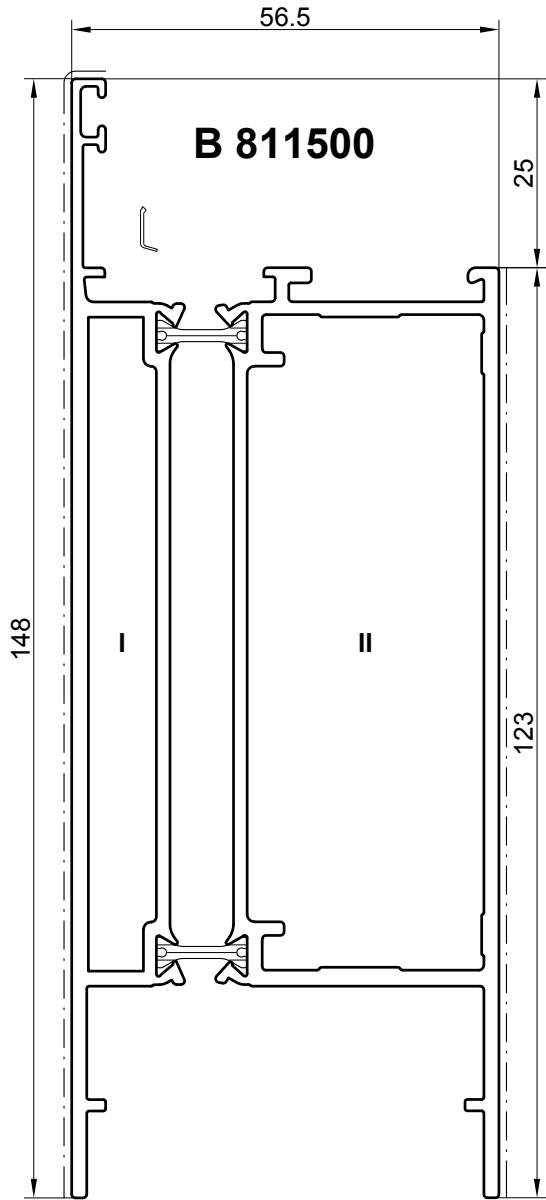











009000120

M 1:1
Scale 1:1



Stanzmesser und Stanzwerkzeuge: siehe Register **Werkzeuge**
Punch knives and punching tools: refer to register **Tools**

M 1:1
Scale 1:1

	Außenkammer External profile chamber					Innenkammer Internal profile chamber					
	I					II					
<ul style="list-style-type: none">  verpressbar crimpable  verstiftbar nailable  nachträglich verklebbar retro gluing after assembly 											
B 811500	Z 914234 L Z 914235 R	-	-	-	-	-	Z 914716	-	2 x Z 914351	Z 911187	Z 914434 Z 914772

010000130

P 811690

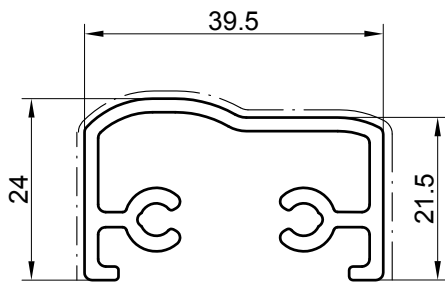

P 811730

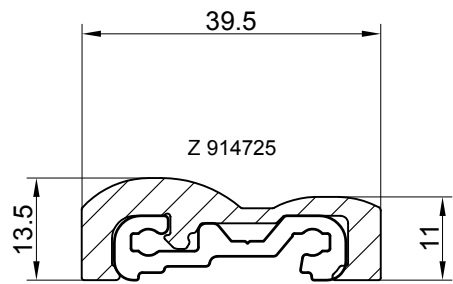

011000150

M 1:1
Scale 1:1