

Dichtungen: siehe Register **Zubehör**
Gaskets: refer to register **Accessories**

M 1:1
Scale 1:1

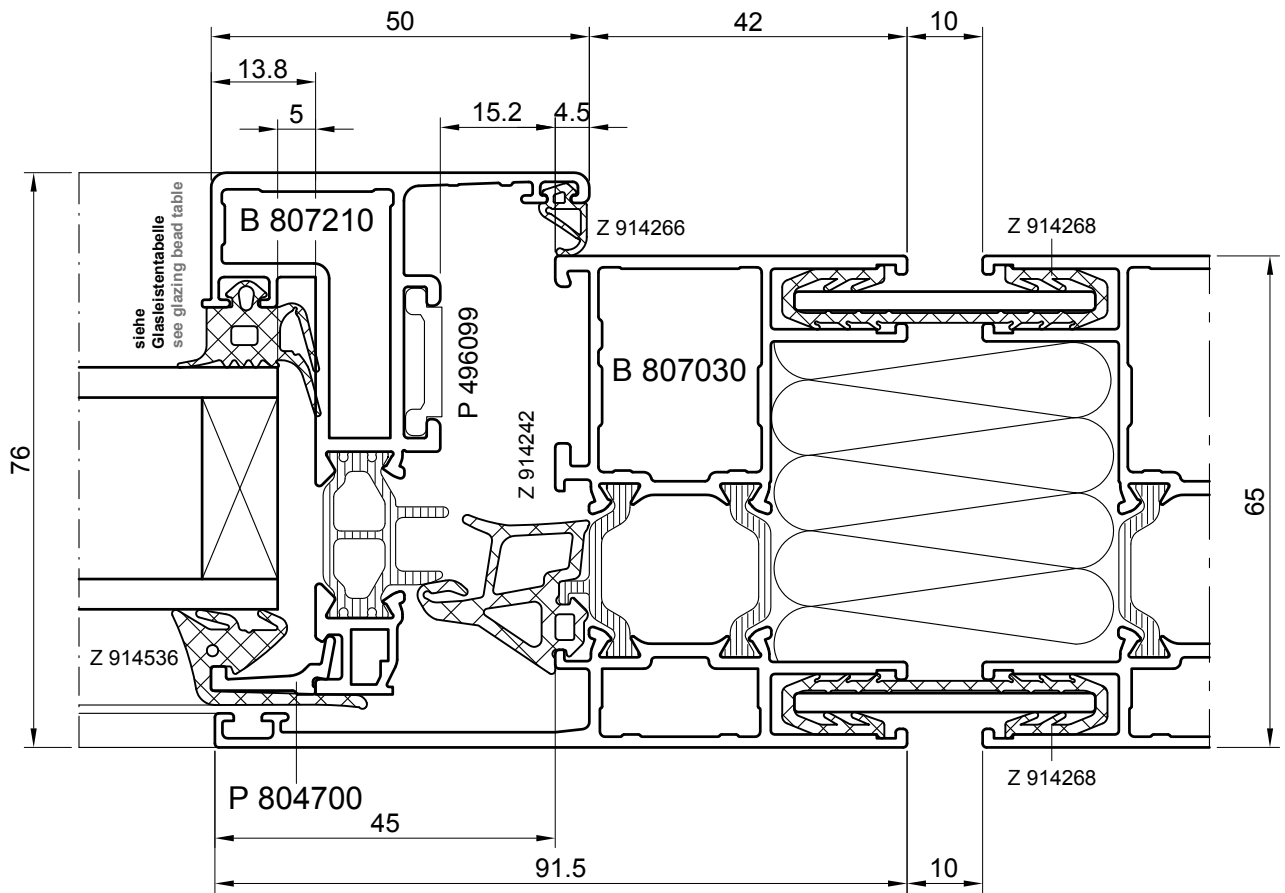
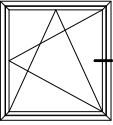

02/1000300

Dichtungen: siehe Register **Zubehör**
Gaskets: refer to register **Accessories**

M 1:1
Scale 1:1

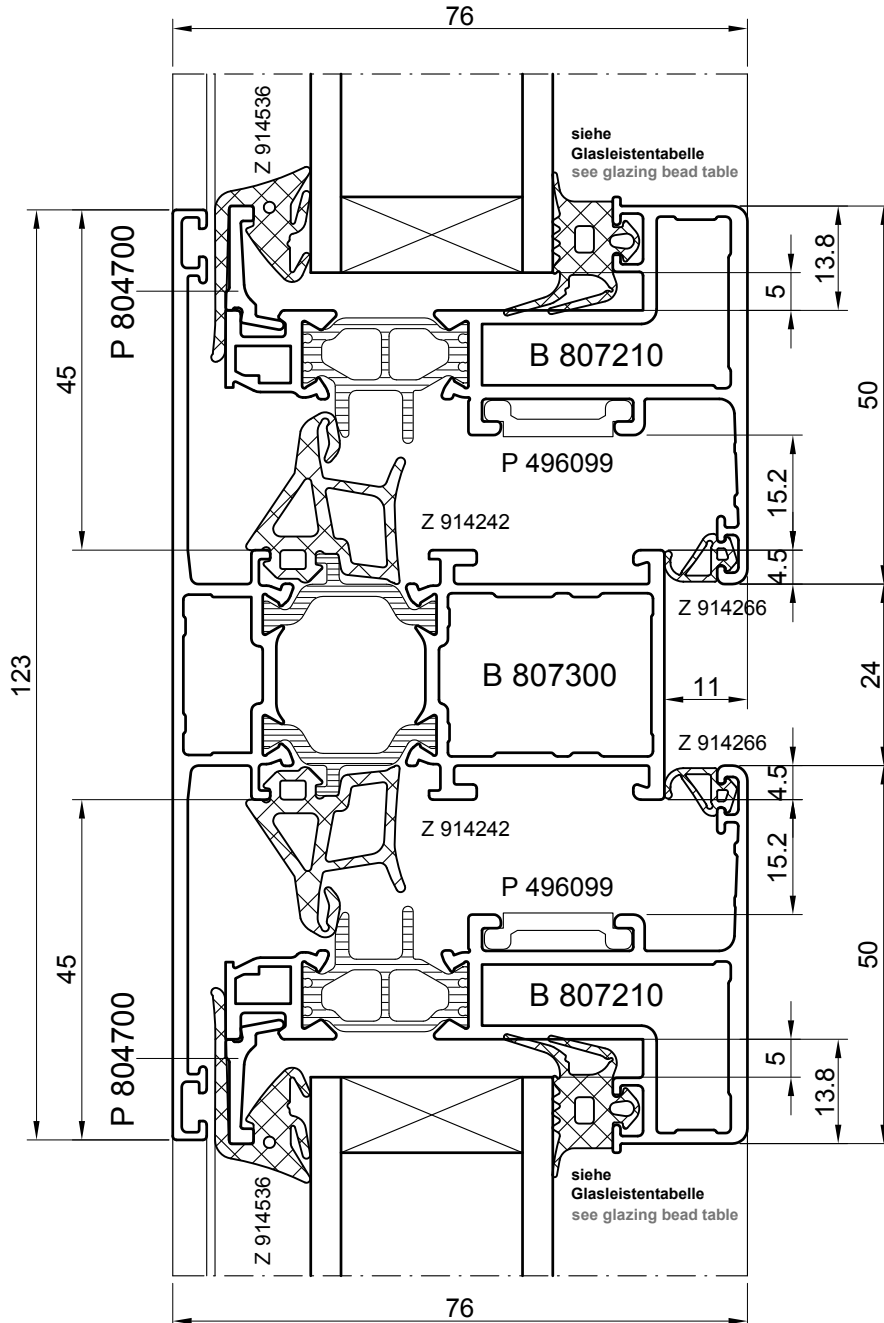
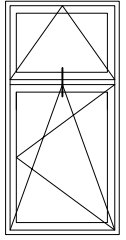

Dichtungen: siehe Register **Zubehör**
Gaskets: refer to register **Accessories**

M 1:1
Scale 1:1

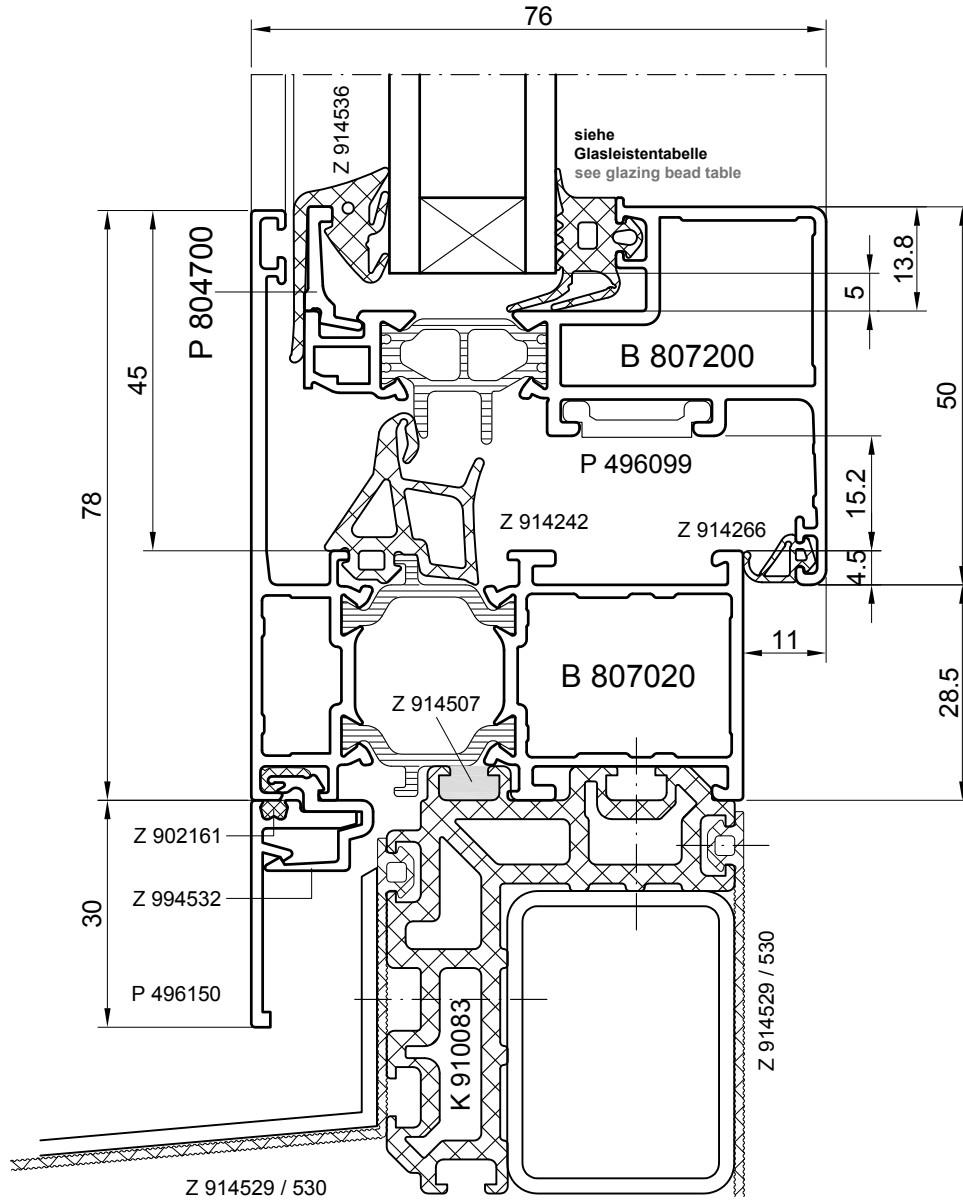
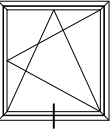

Details: siehe Register **Zusatzprofile / Schnitte**
Details: refer to register **Supplementary profiles / Sections**

M 1:1
Scale 1:1

023000500

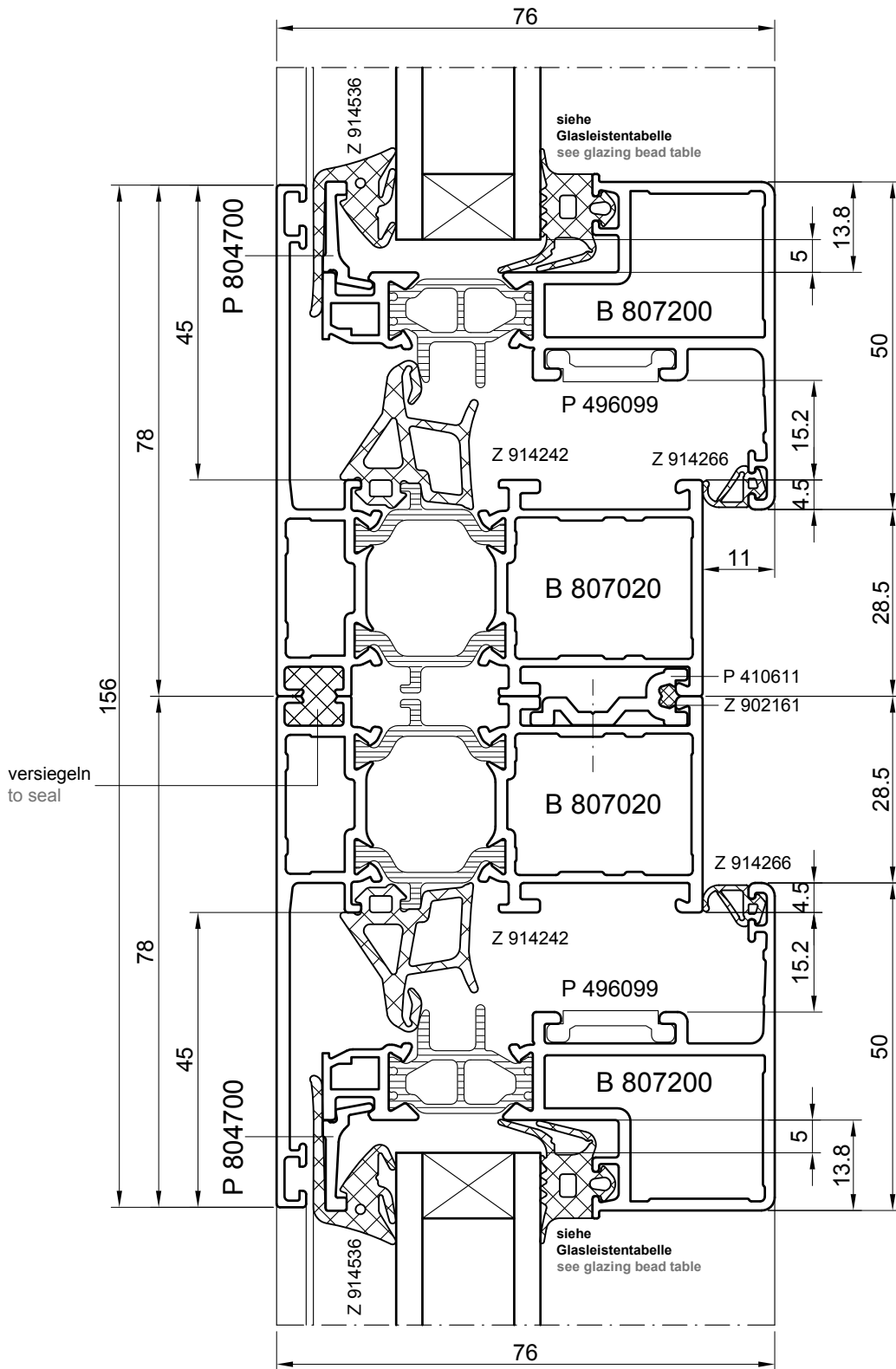
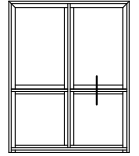

Dichtungen: siehe Register **Zubehör**
Gaskets: refer to register **Accessories**

M 1:1
Scale 1:1

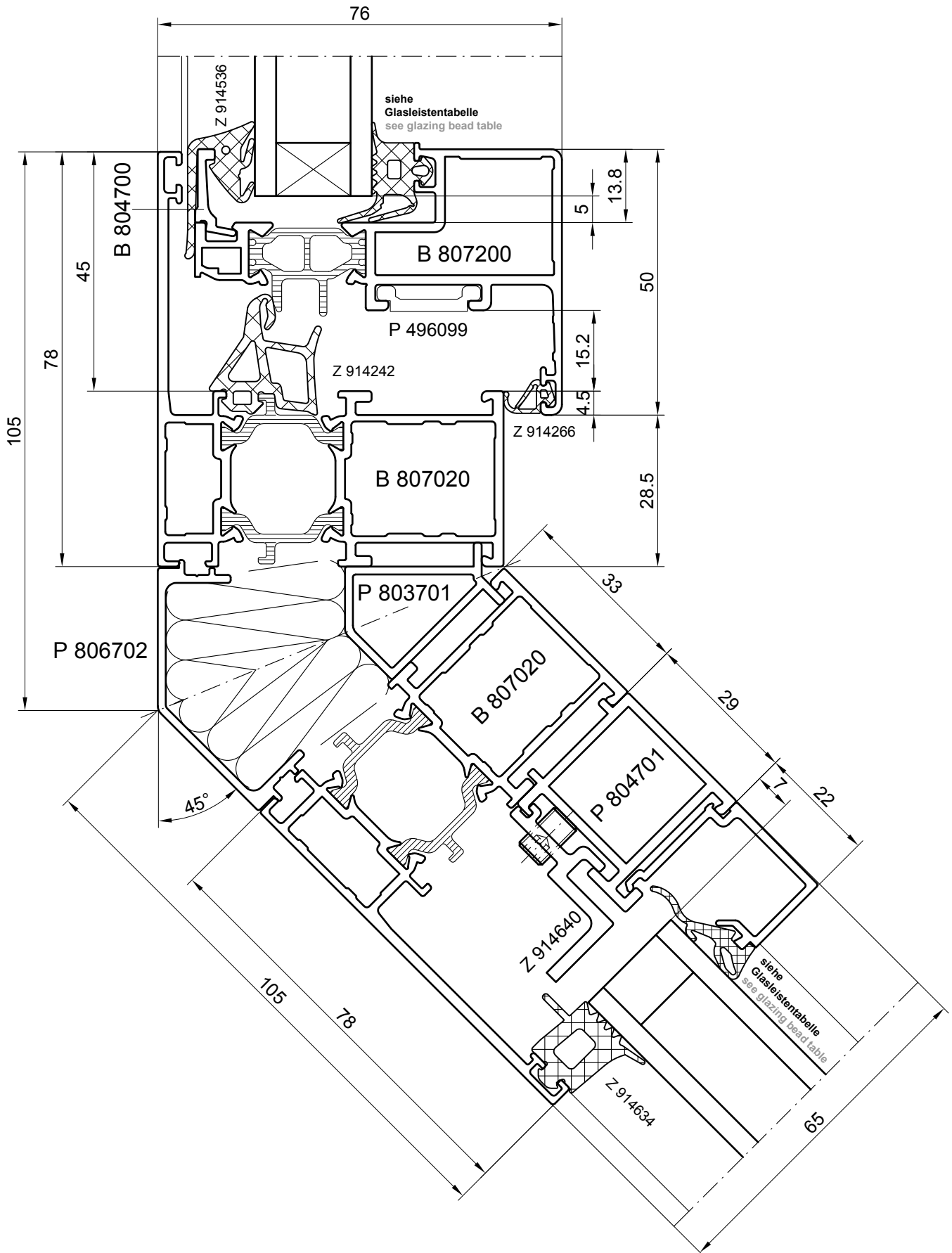

025000700

Dichtungen: siehe Register **Zubehör**
Gaskets: refer to register **Accessories**

M 1:1
Scale 1:1

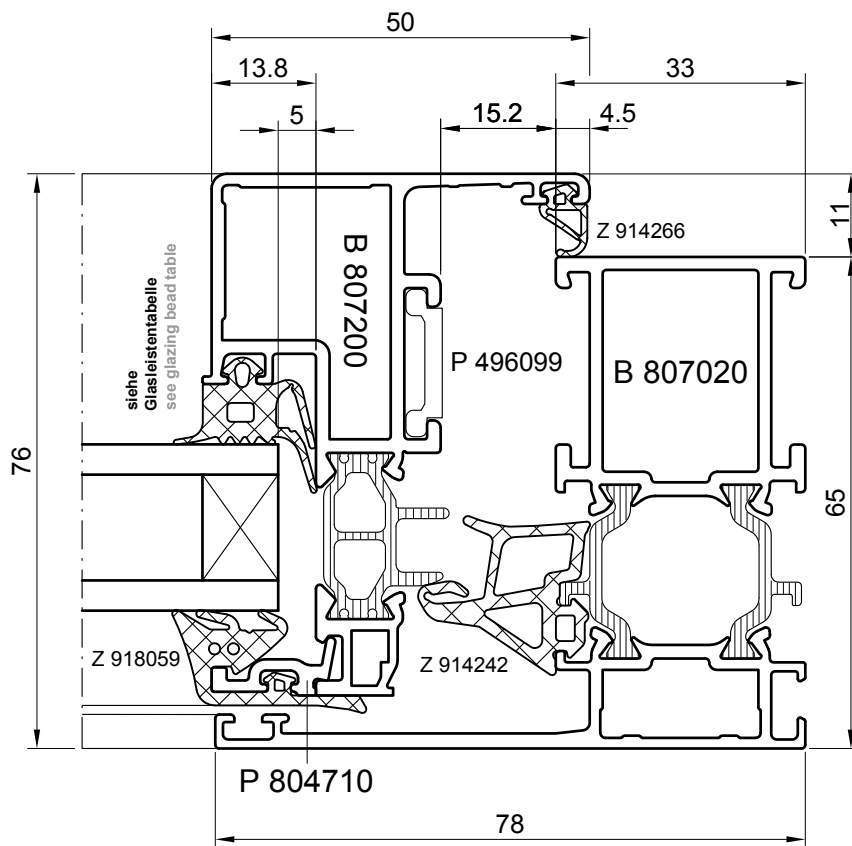
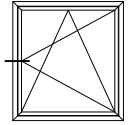

Dichtungen: siehe Register **Zubehör**
Gaskets: refer to register **Accessories**

M 1:1
Scale 1:1