

Dichtungen: siehe Register **Zubehör**
Gaskets: refer to register **Accessories**

M 1:1
Scale 1:1

065000100

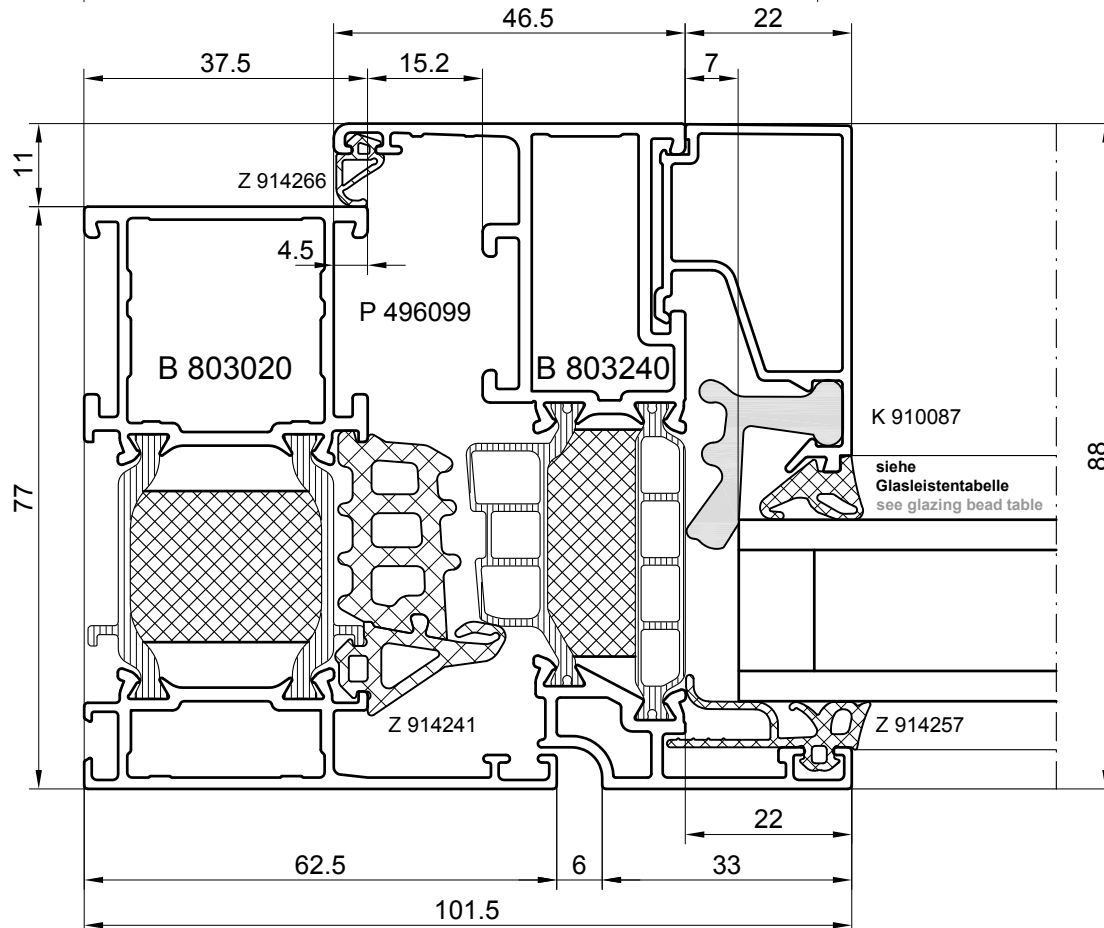
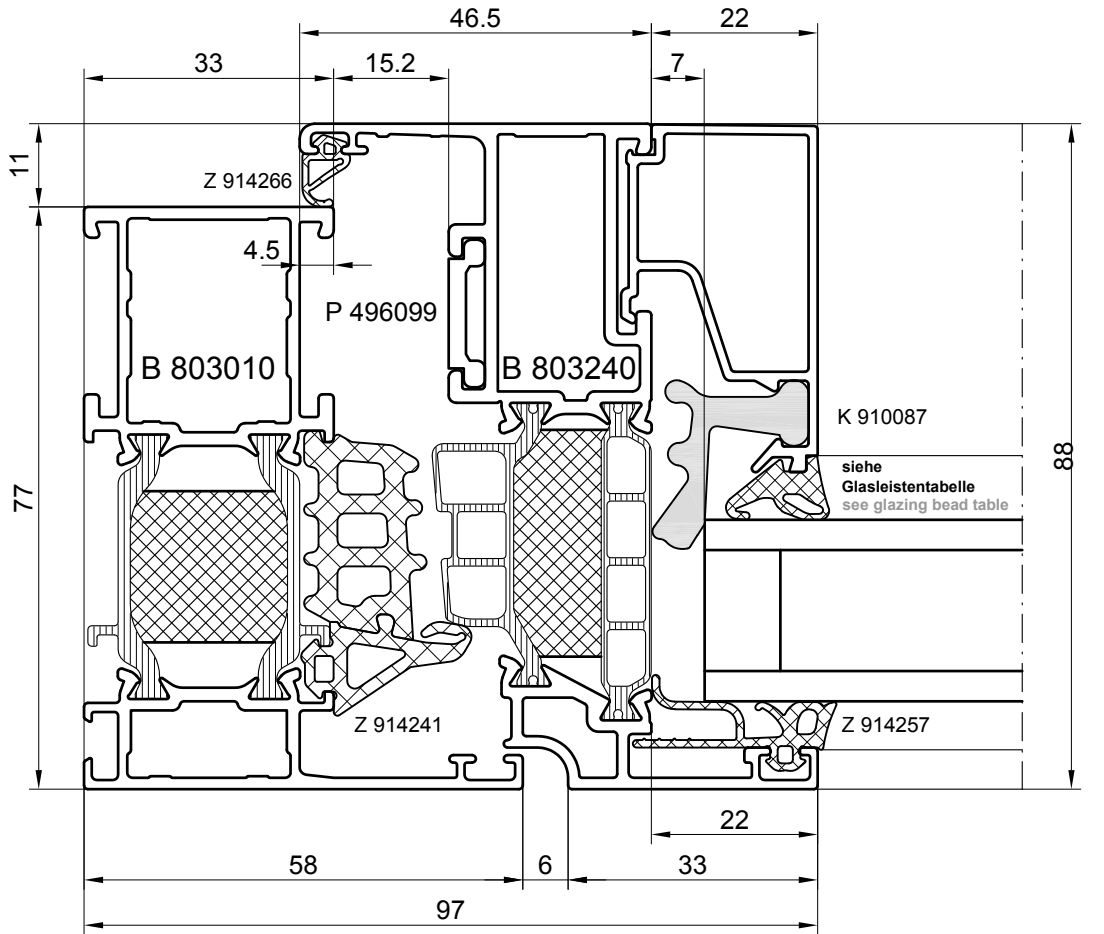

Dichtungen: siehe Register **Zubehör**
Gaskets: refer to register **Accessories**

M 1:1
Scale 1:1

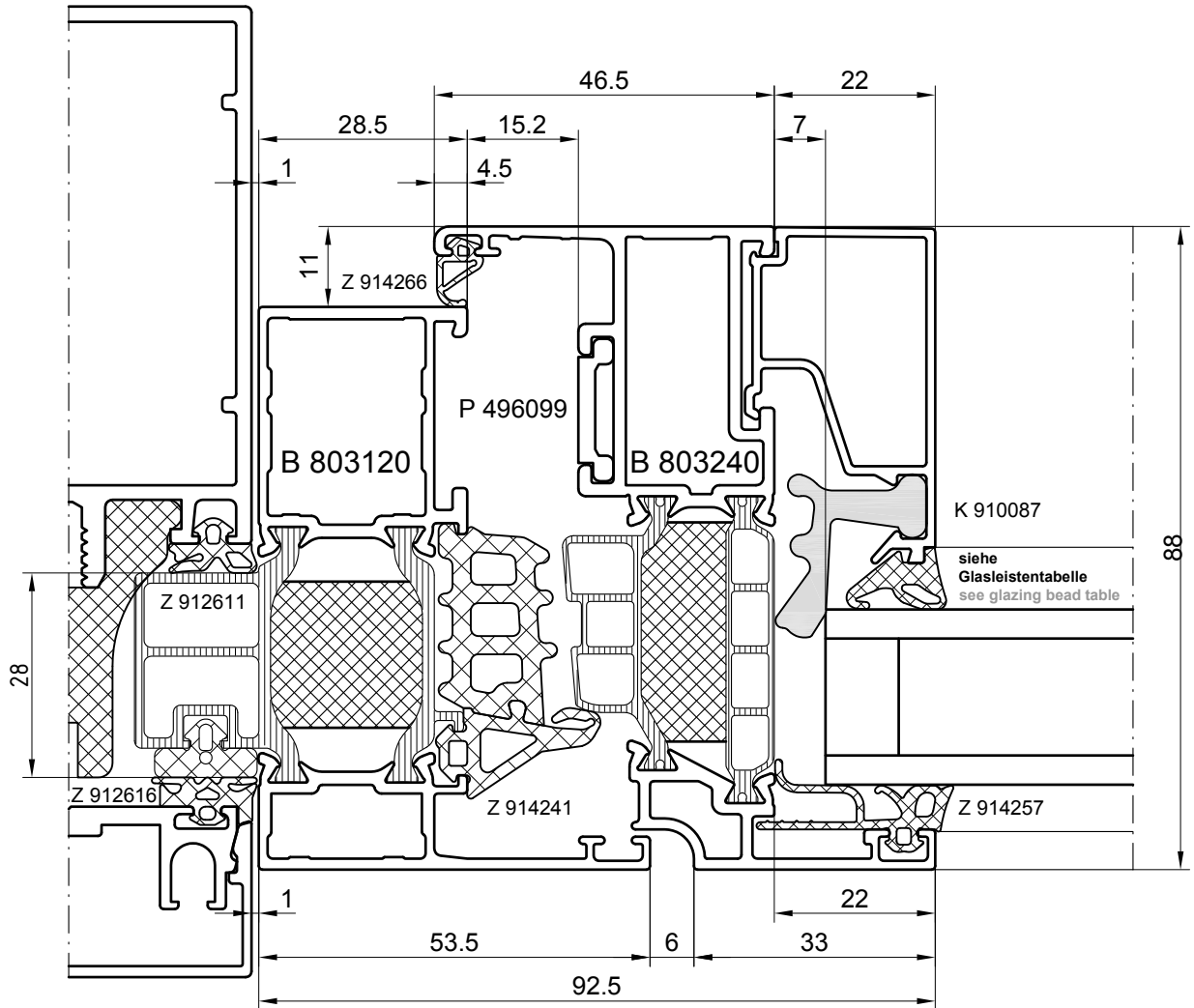
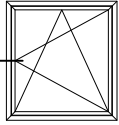

067003000

Dichtungen: siehe Register **Zubehör**
Gaskets: refer to register **Accessories**

M 1:1
Scale 1:1

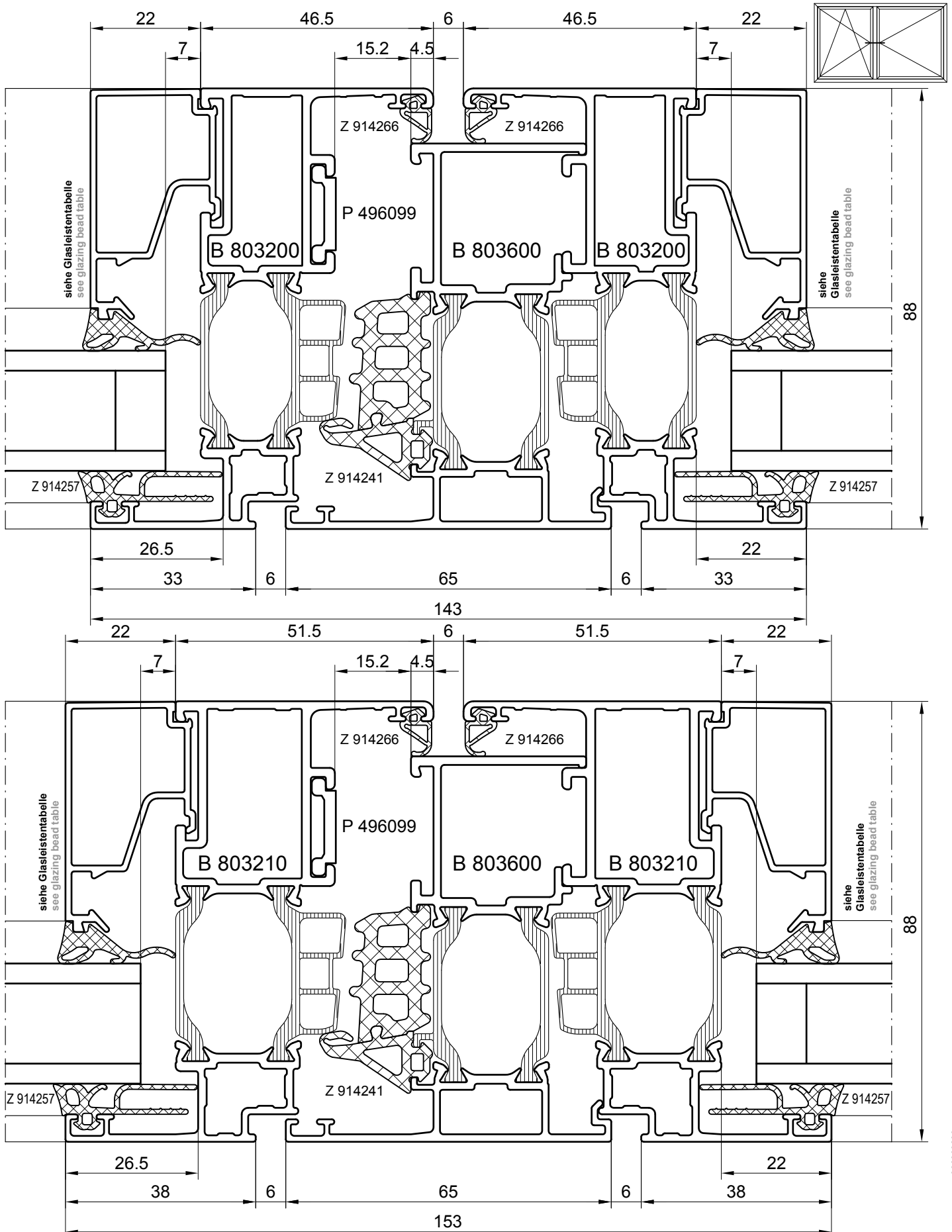

Dichtungen: siehe Register **Zubehör**
Gaskets: refer to register **Accessories**

M 1:1
Scale 1:1

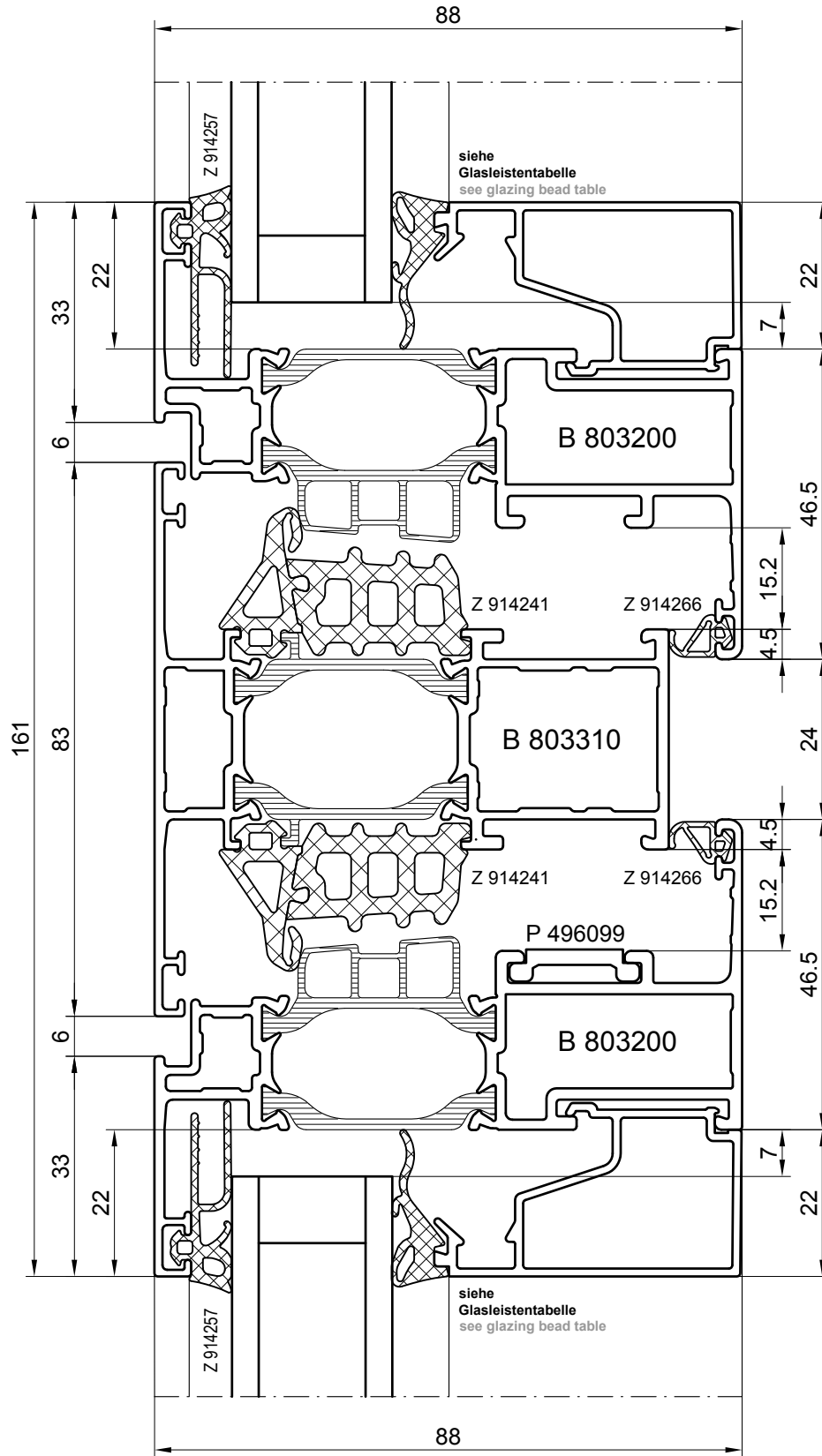
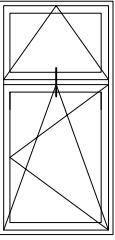

068000300

Dichtungen: siehe Register **Zubehör**
Gaskets: refer to register **Accessories**

M 1:1
Scale 1:1

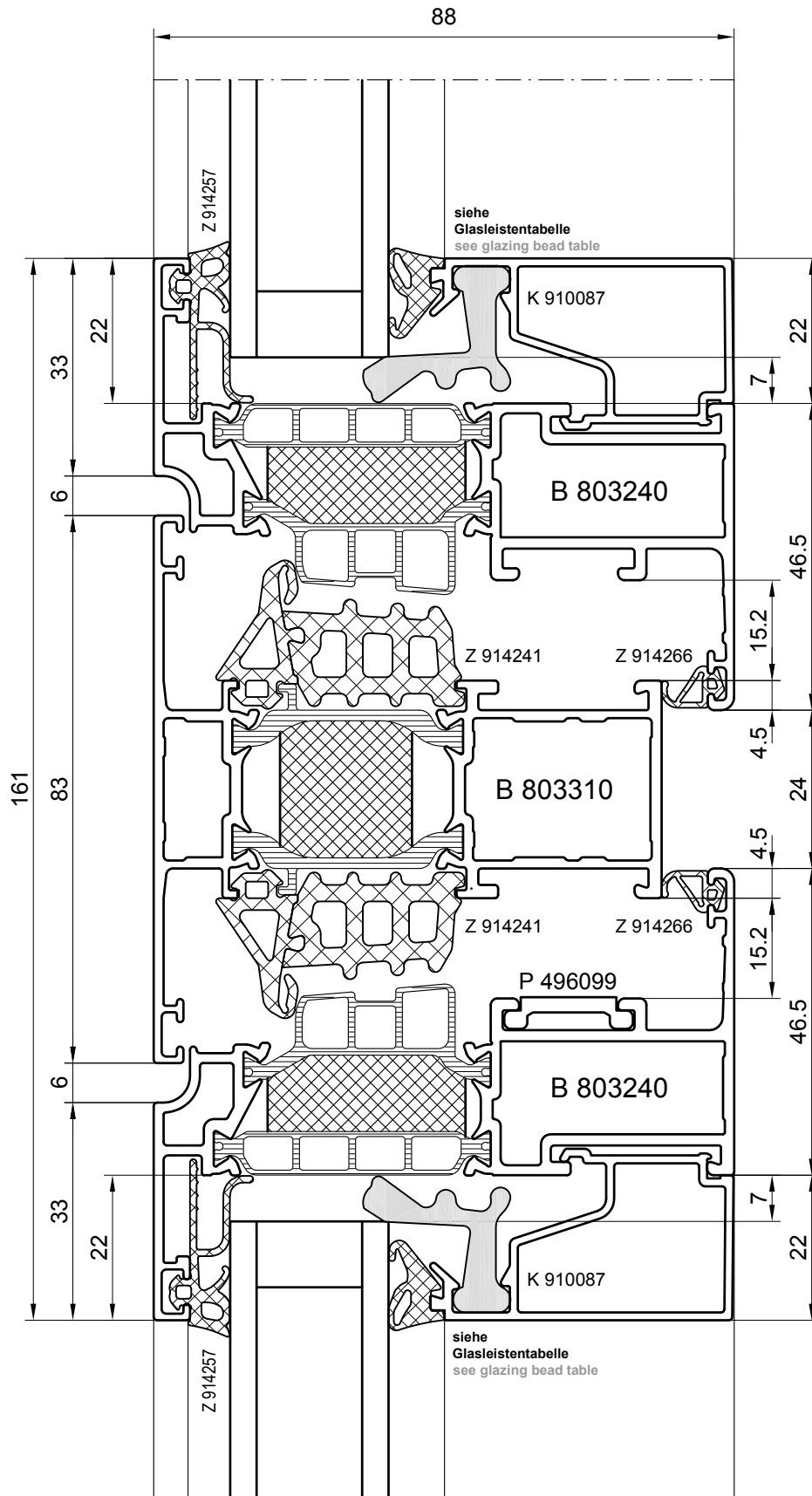
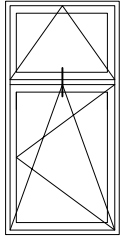

070002900

Dichtungen: siehe Register **Zubehör**
Gaskets: refer to register **Accessories**

M 1:1
Scale 1:1

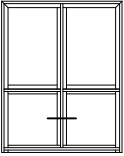
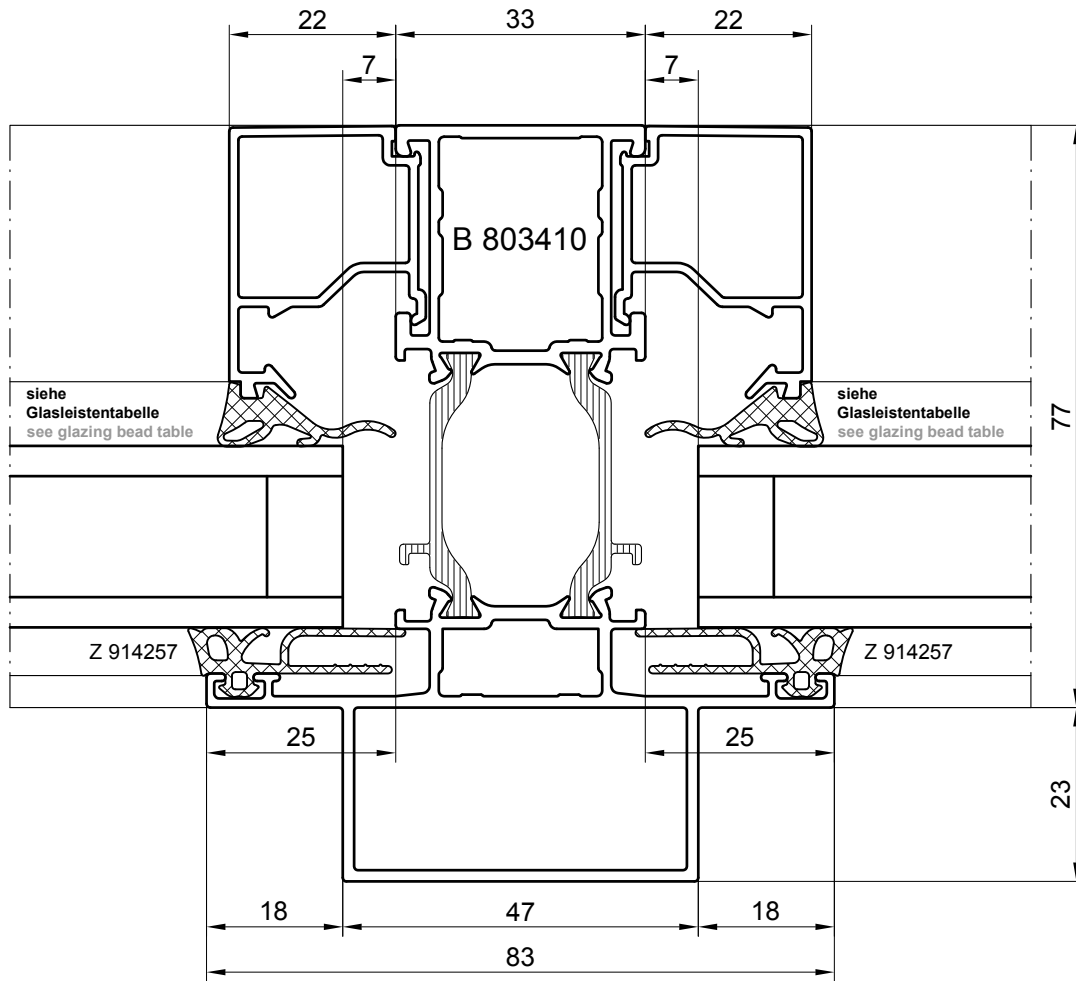

Verglasung von außen
Glazing from the outside

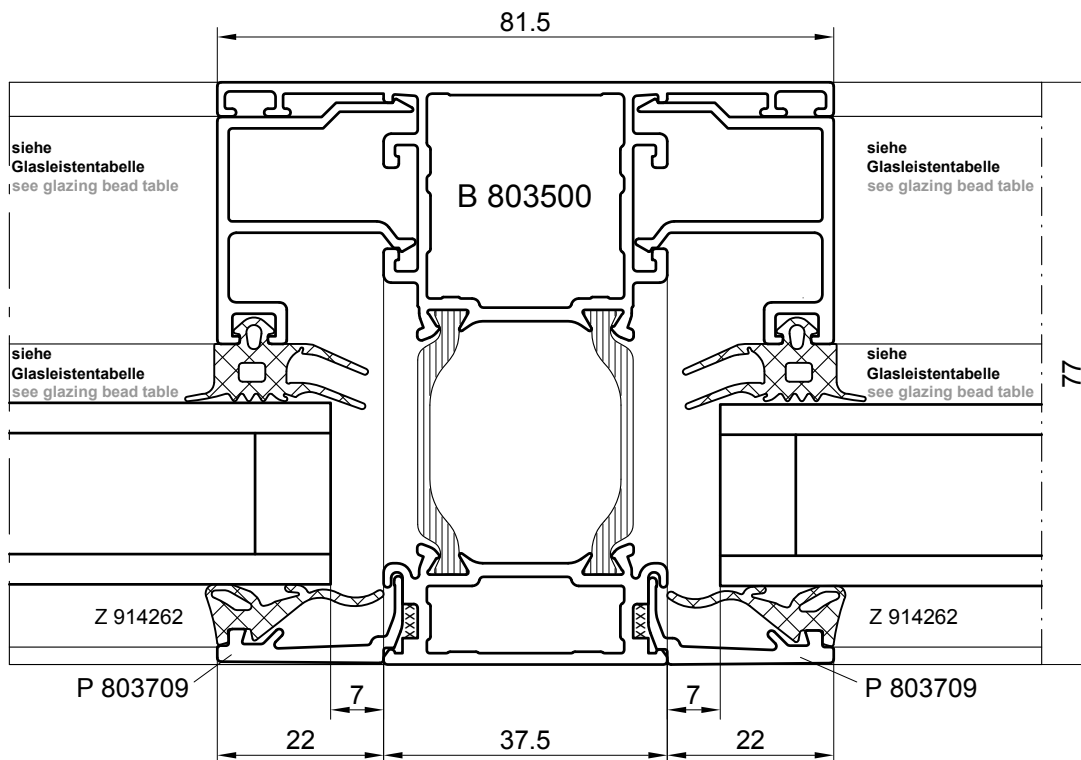

071000400

Dichtungen: siehe Register **Zubehör**
Gaskets: refer to register **Accessories**

M 1:1
Scale 1:1

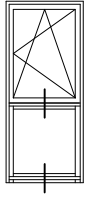
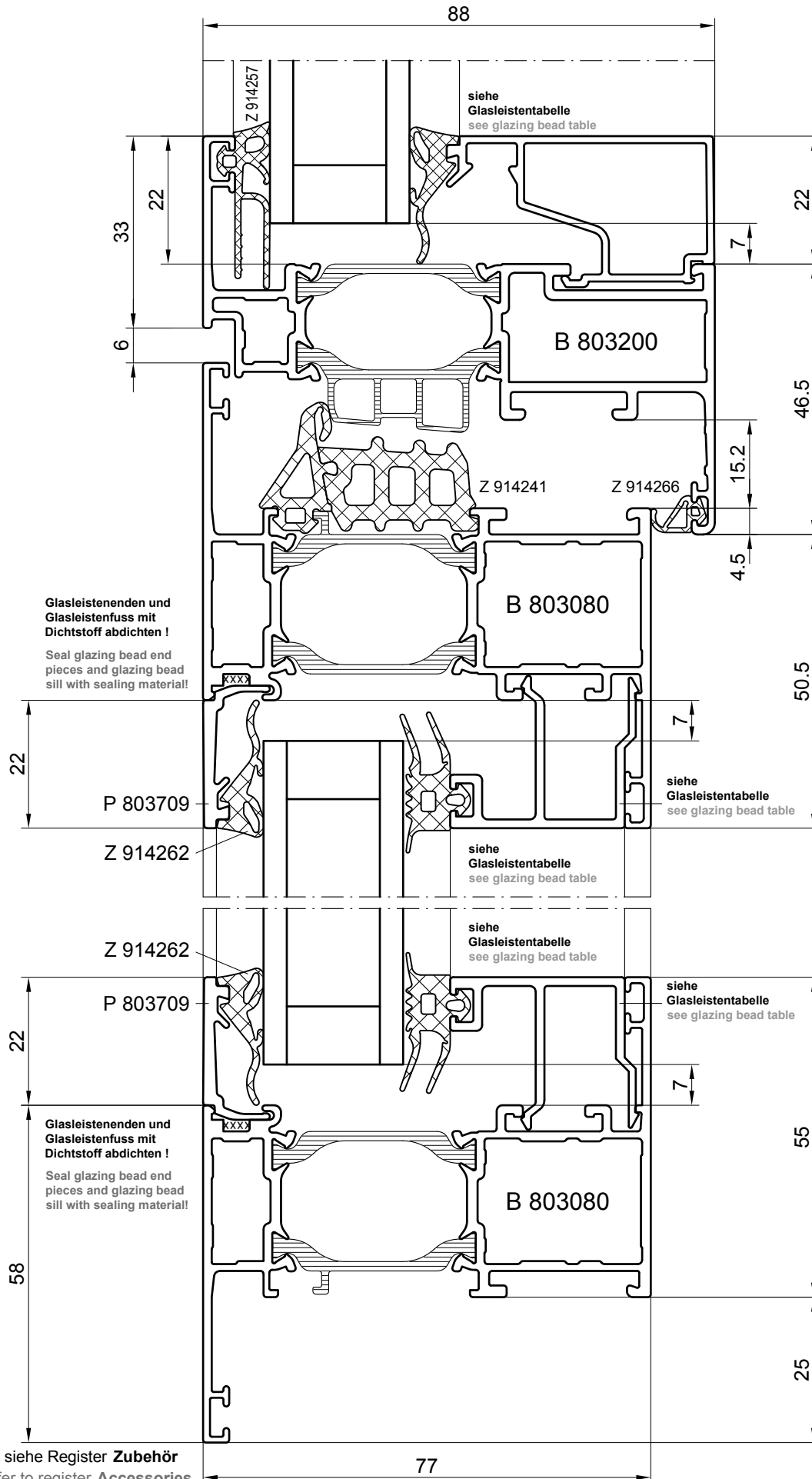

072000500

M 1:1
Scale 1:1

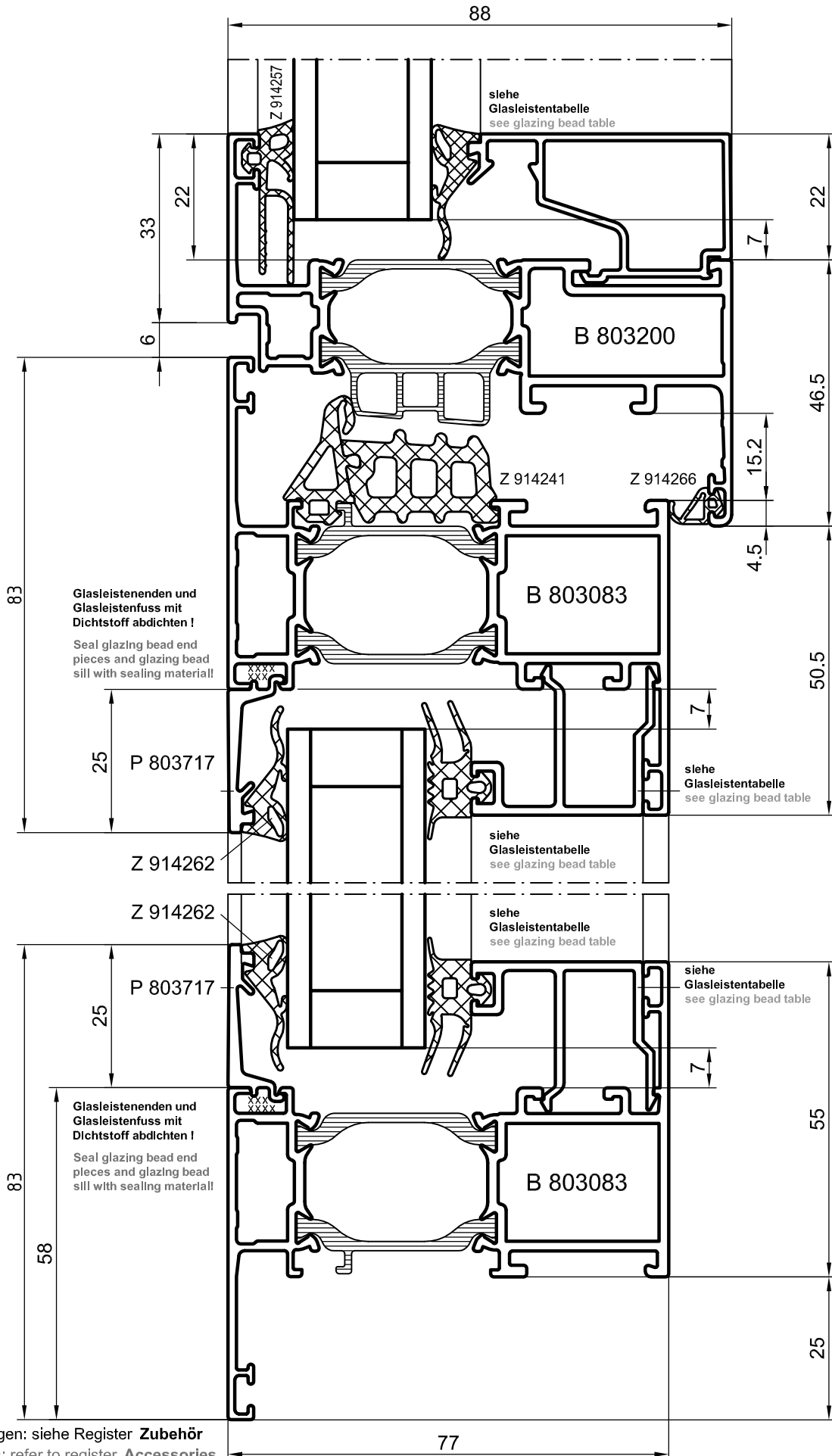

Dichtungen: siehe Register **Zubehör**
Gaskets: refer to register **Accessories**

M 1:1
Scale 1:1

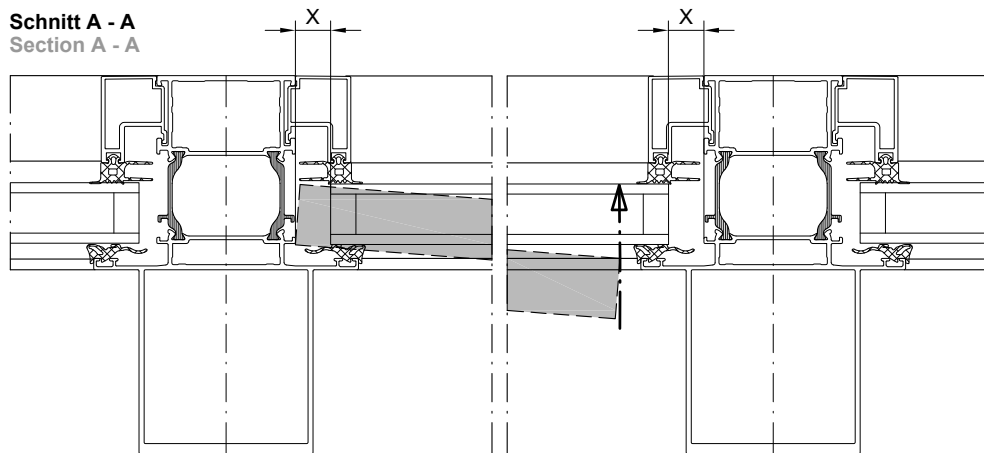
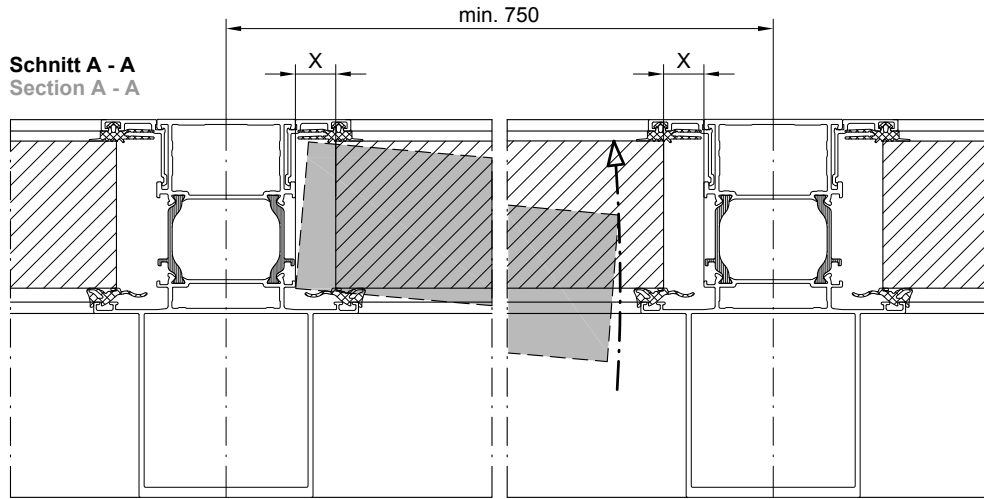

Schnitt B - B
Section B - B

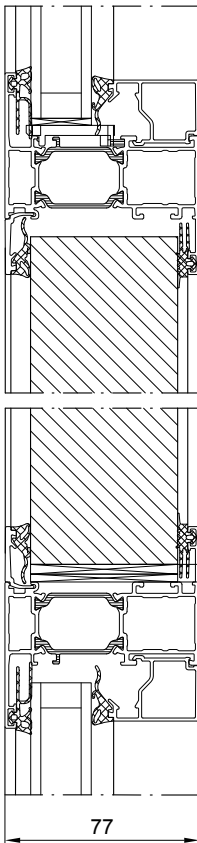

Schnitt B - B
Section B - B

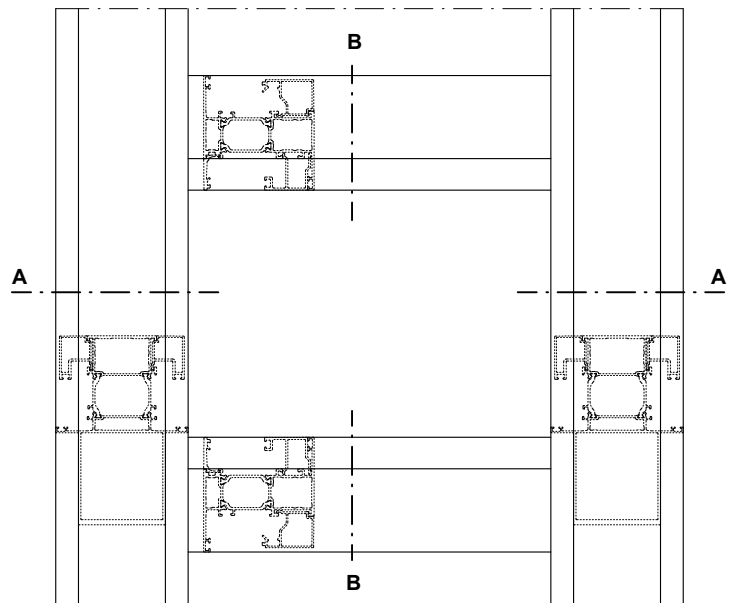
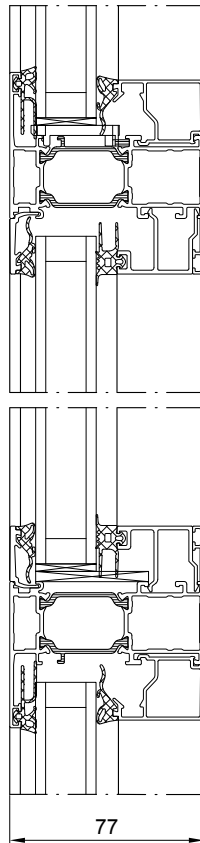

Maß X	Dimension X	Füllungsdicke	Filling thickness
14 mm		< 28 mm	
16 mm		28 mm - 58 mm	

07.30.00600

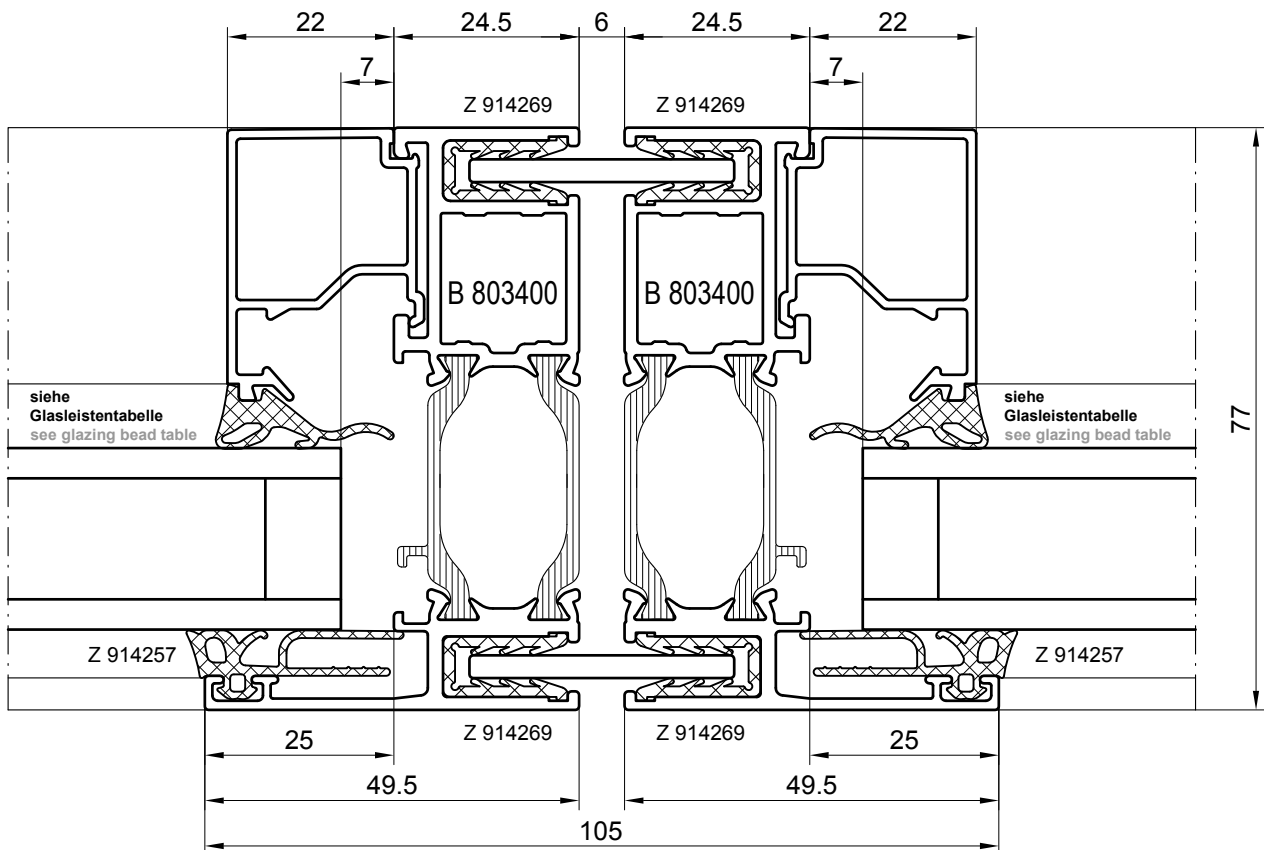
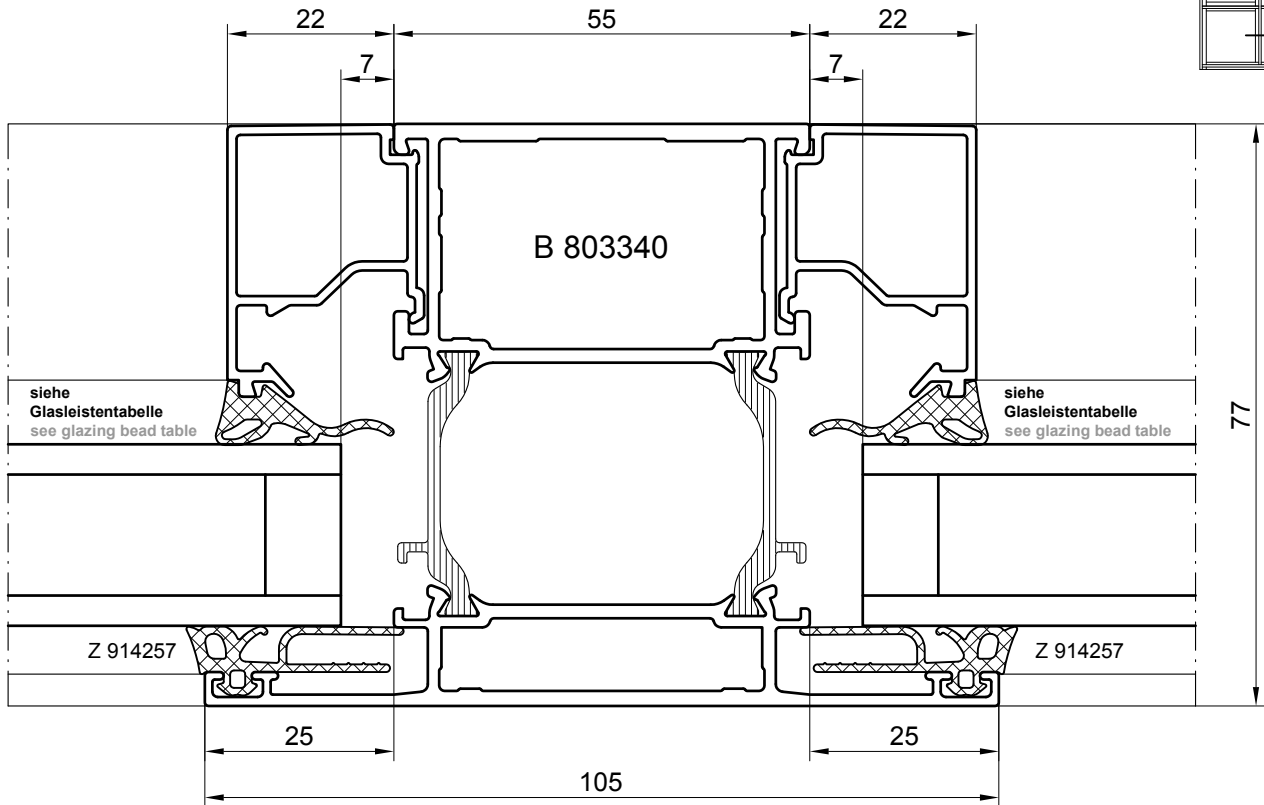
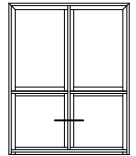

074000700

Dichtungen: siehe Register **Zubehör**
Gaskets: refer to register **Accessories**

M 1:1
Scale 1:1

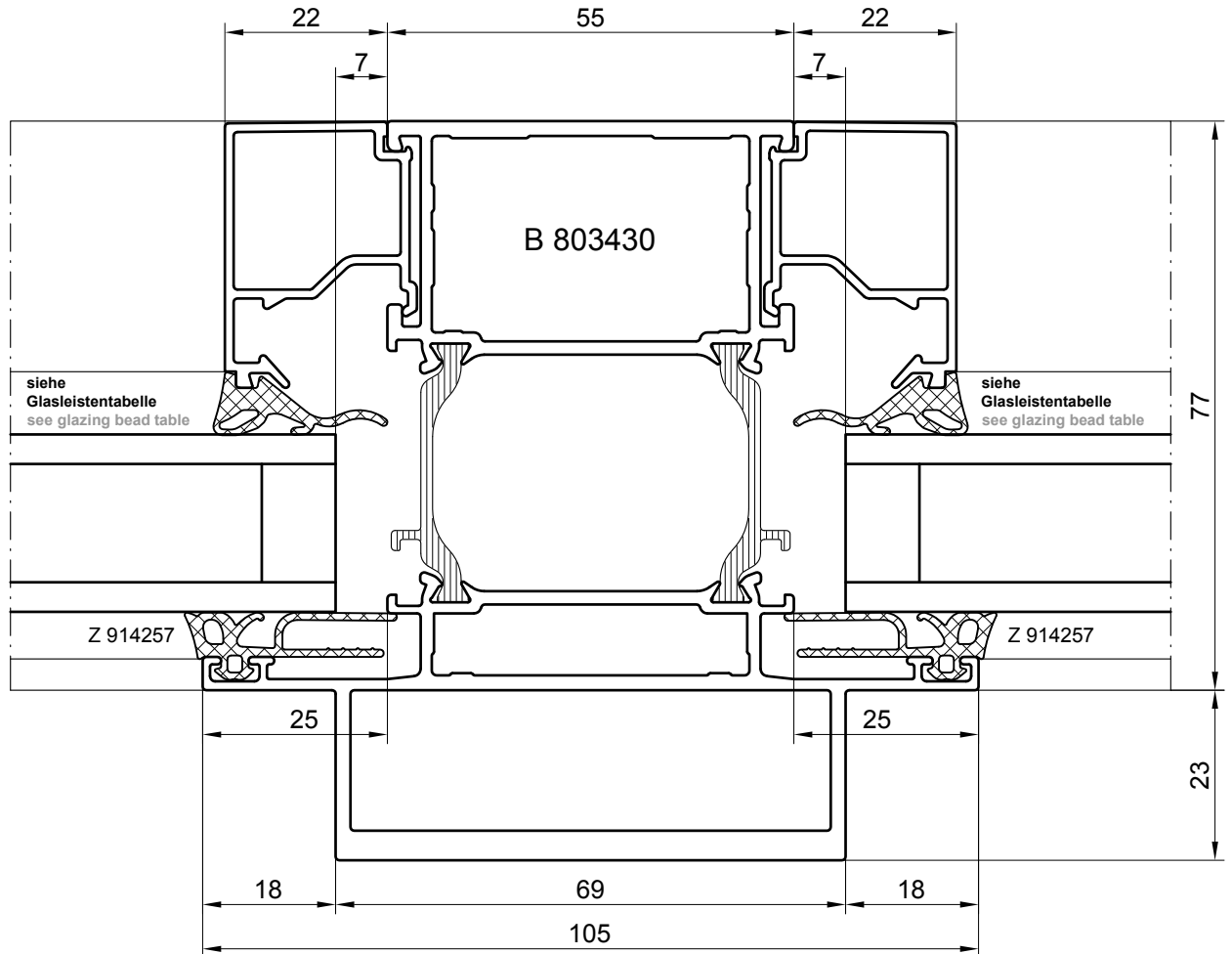
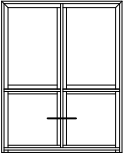

075000800

Dichtungen: siehe Register **Zubehör**
Gaskets: refer to register **Accessories**

M 1:1
Scale 1:1

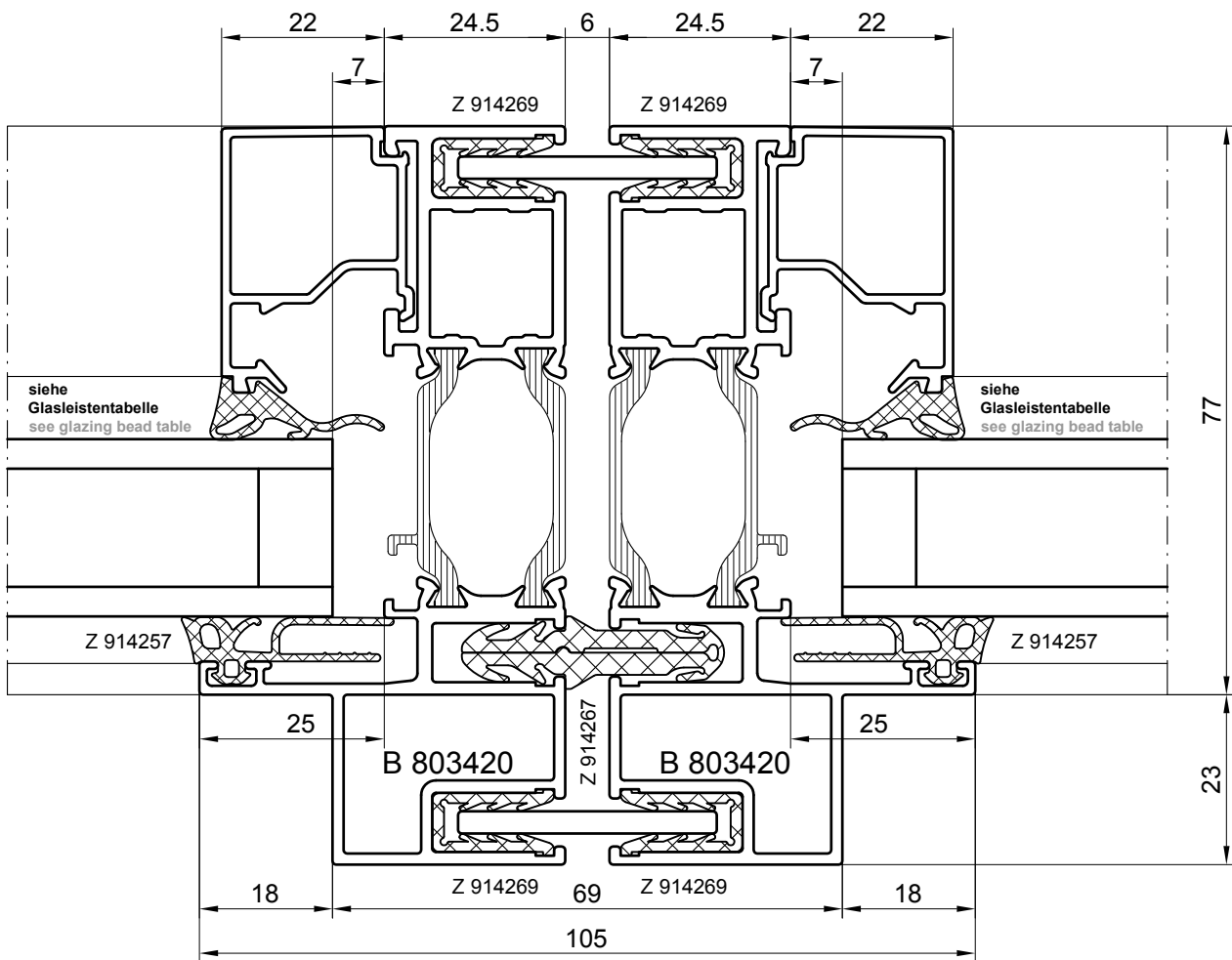
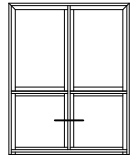

Dichtungen: siehe Register **Zubehör**
Gaskets: refer to register **Accessories**

M 1:1
Scale 1:1

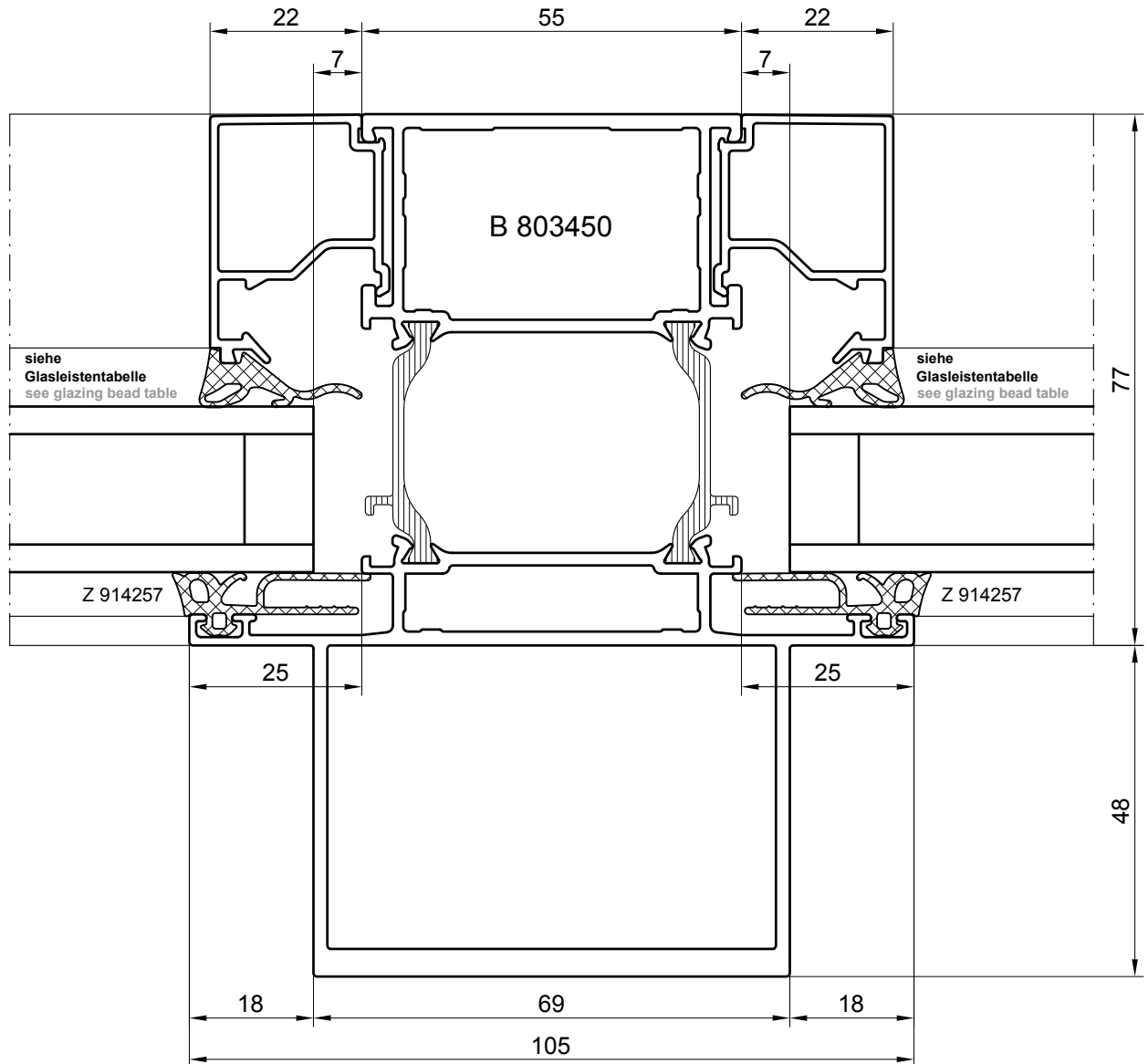
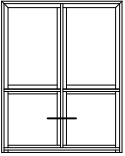

077001000

Dichtungen: siehe Register **Zubehör**
Gaskets: refer to register **Accessories**

M 1:1
Scale 1:1

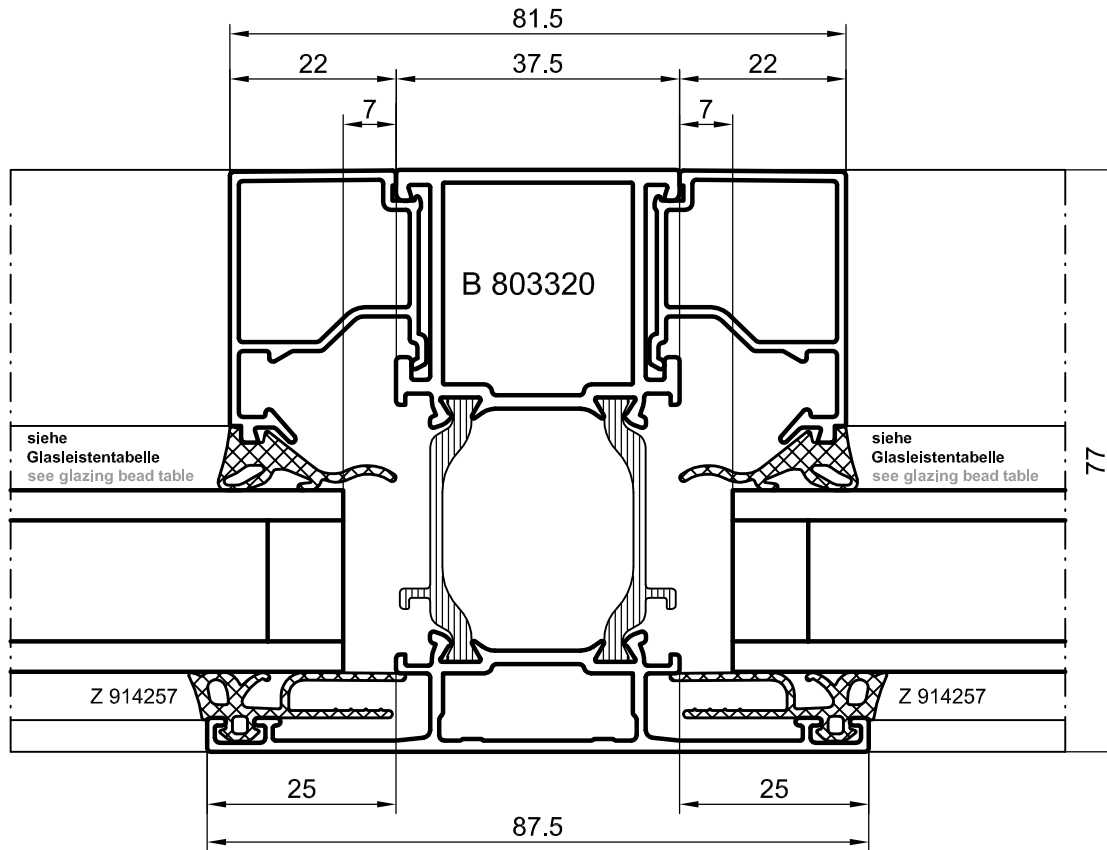
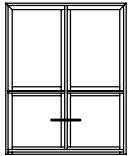

Verglasung von außen
Glazing from the outside

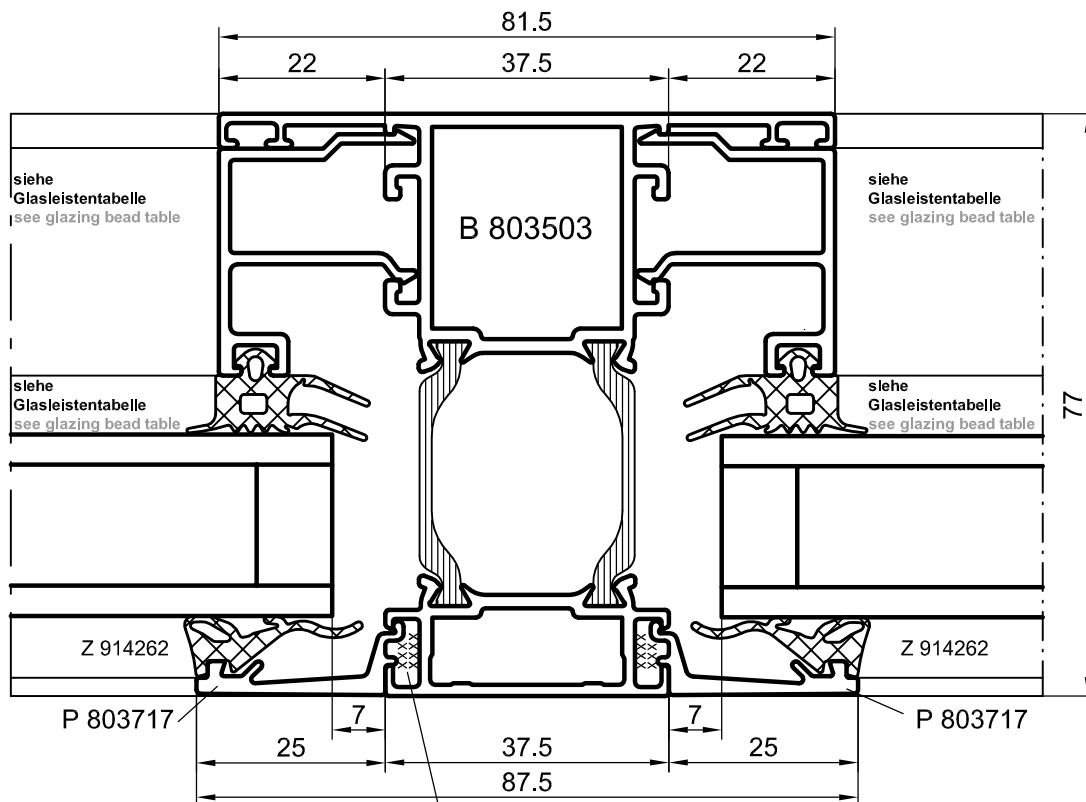

Dichtungen: siehe Register **Zubehör**
Gaskets: refer to register **Accessories**

Glasleistenenden und Glasleistenfuß mit Dichtstoff abdichten!
Seal glazing bead end pieces and glazing bead sill with sealing material!

M 1:1
Scale 1:1

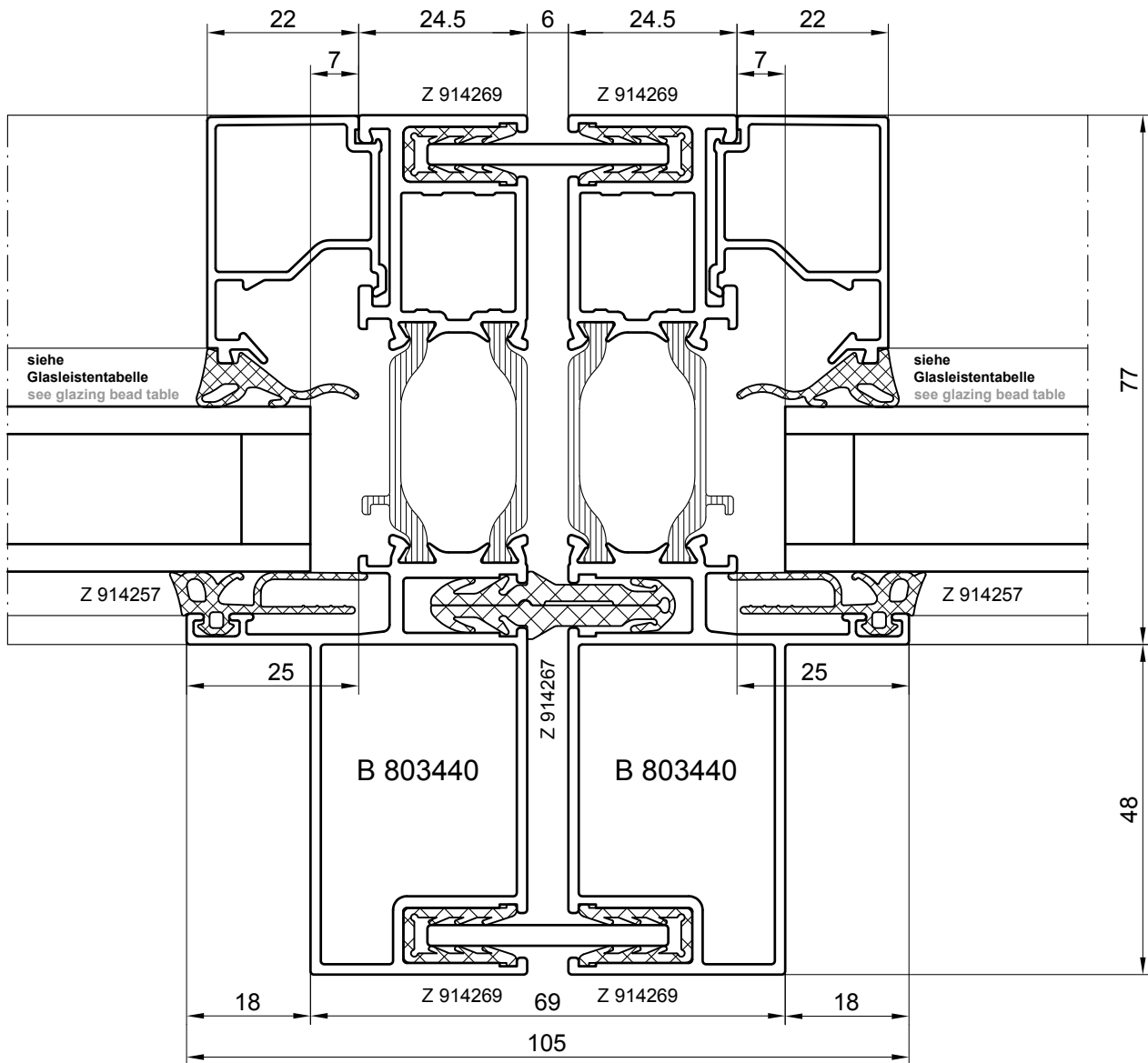
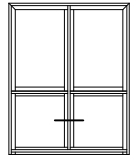

Dichtungen: siehe Register **Zubehör**
Gaskets: refer to register **Accessories**

M 1:1
Scale 1:1

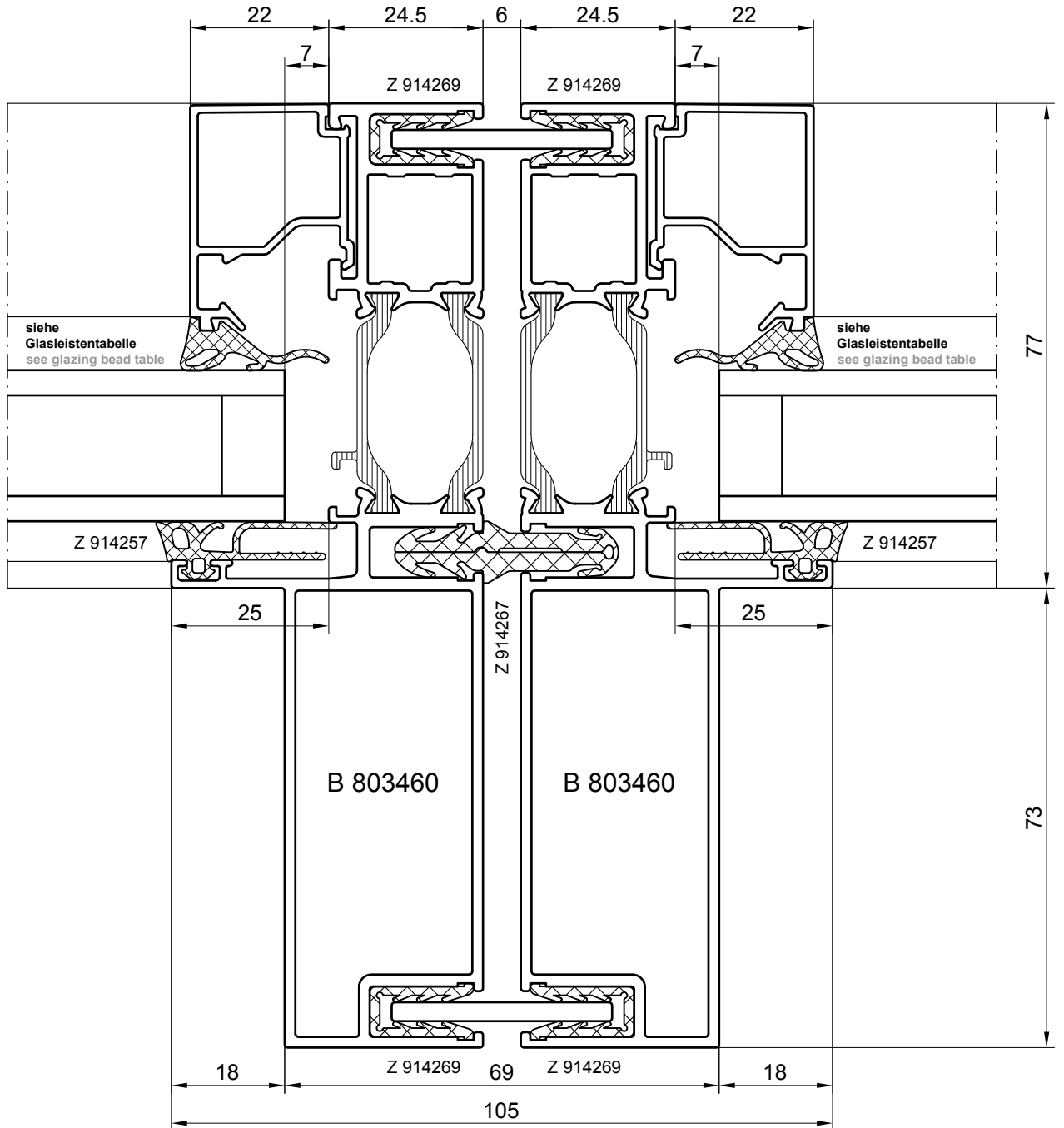
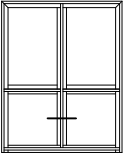

078001200

Dichtungen: siehe Register **Zubehör**
Gaskets: refer to register **Accessories**

M 1:1
Scale 1:1

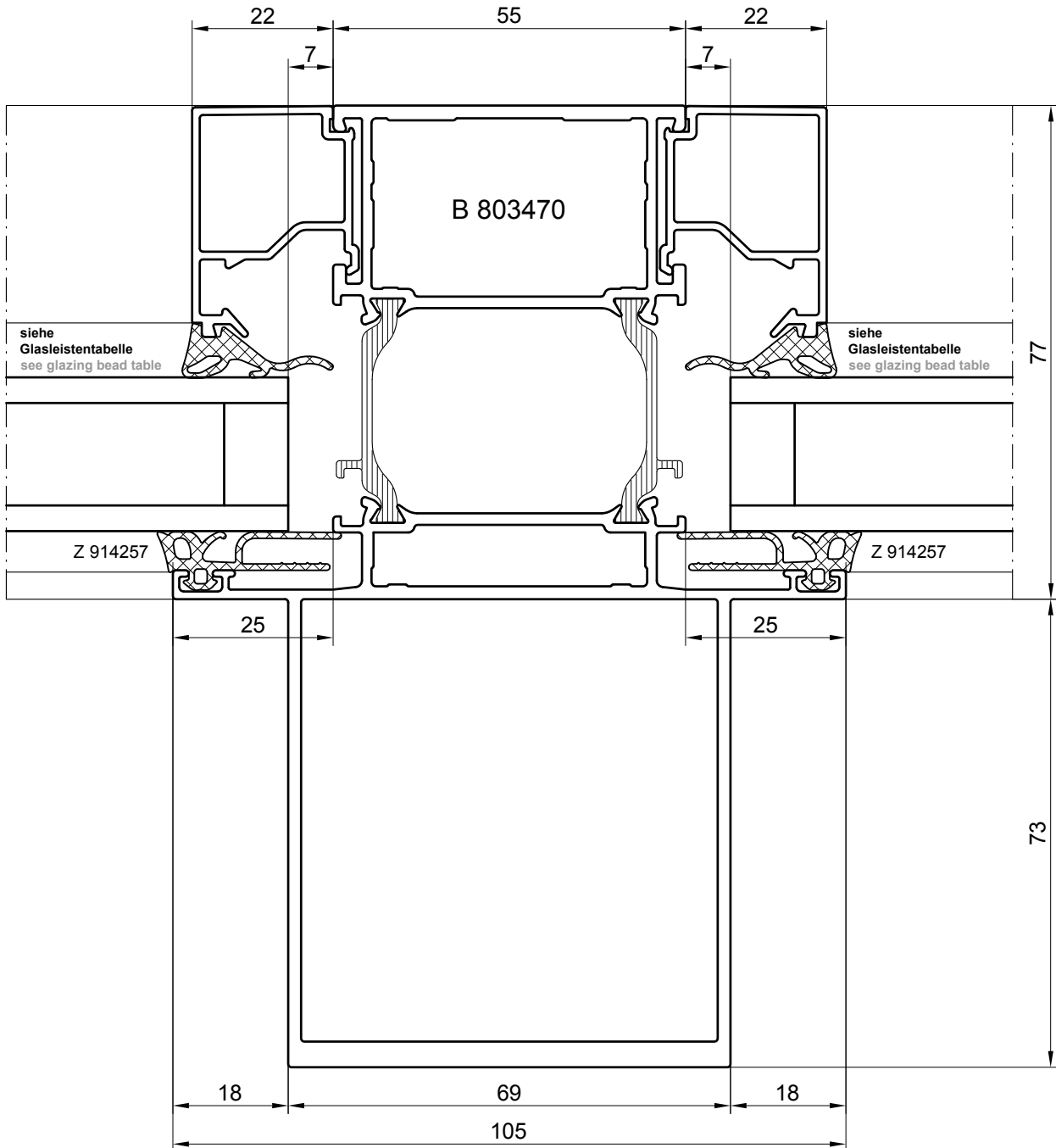
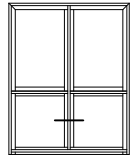

Dichtungen: siehe Register **Zubehör**
Gaskets: refer to register **Accessories**

M 1:1
Scale 1:1

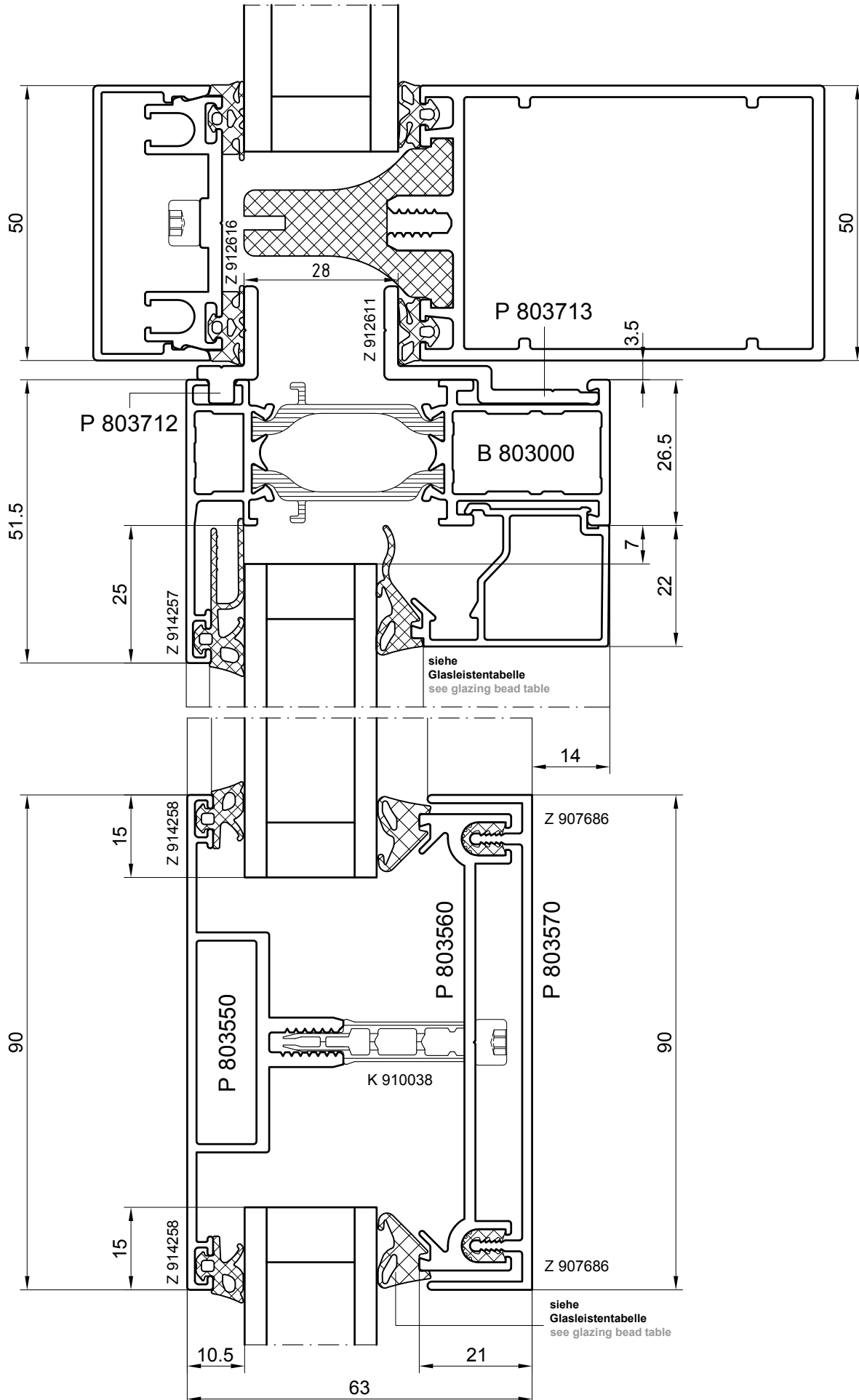
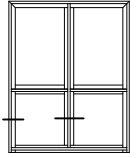

082003500

M 1:1
Scale 1:1

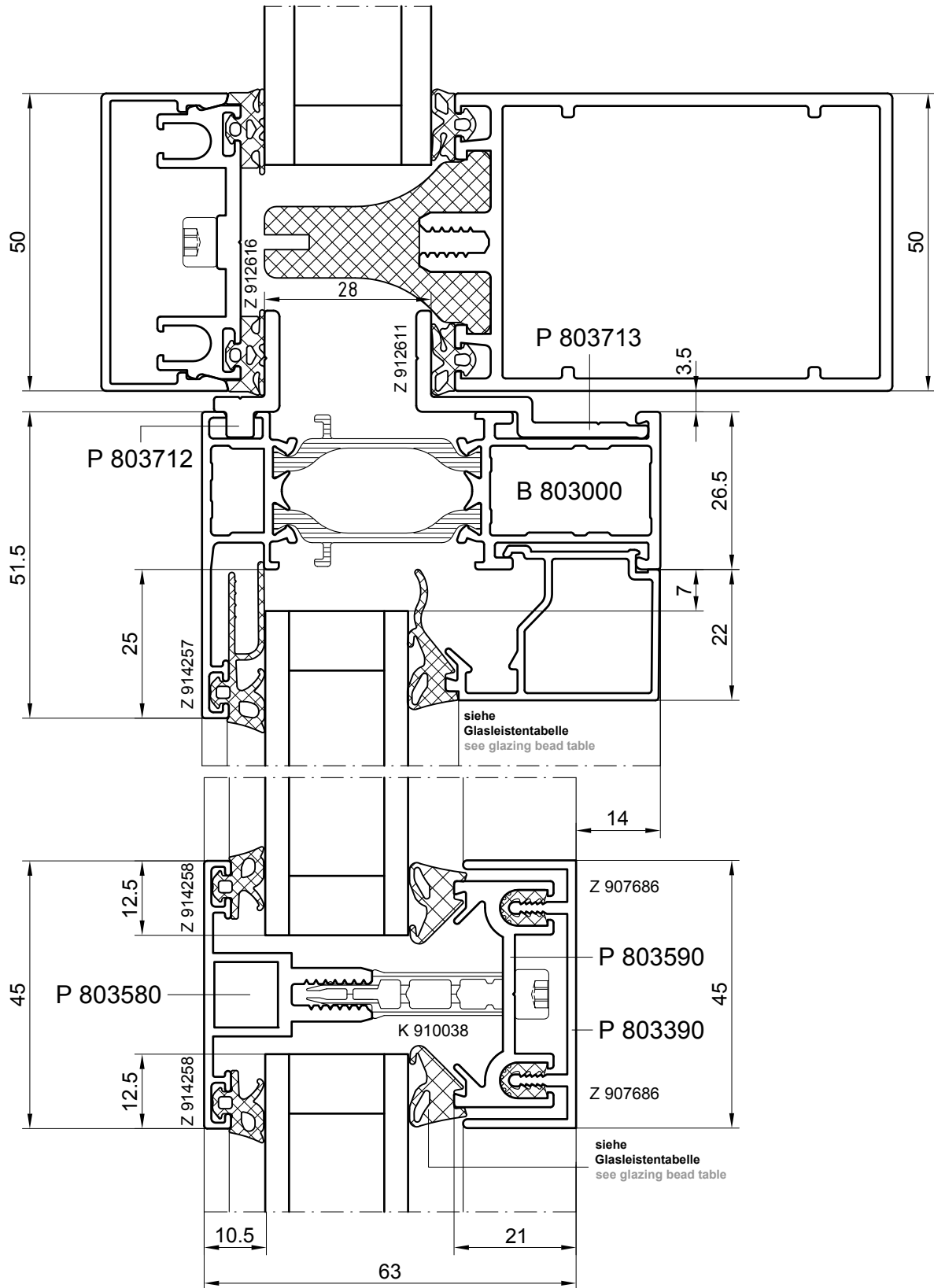
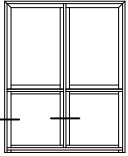

083003600

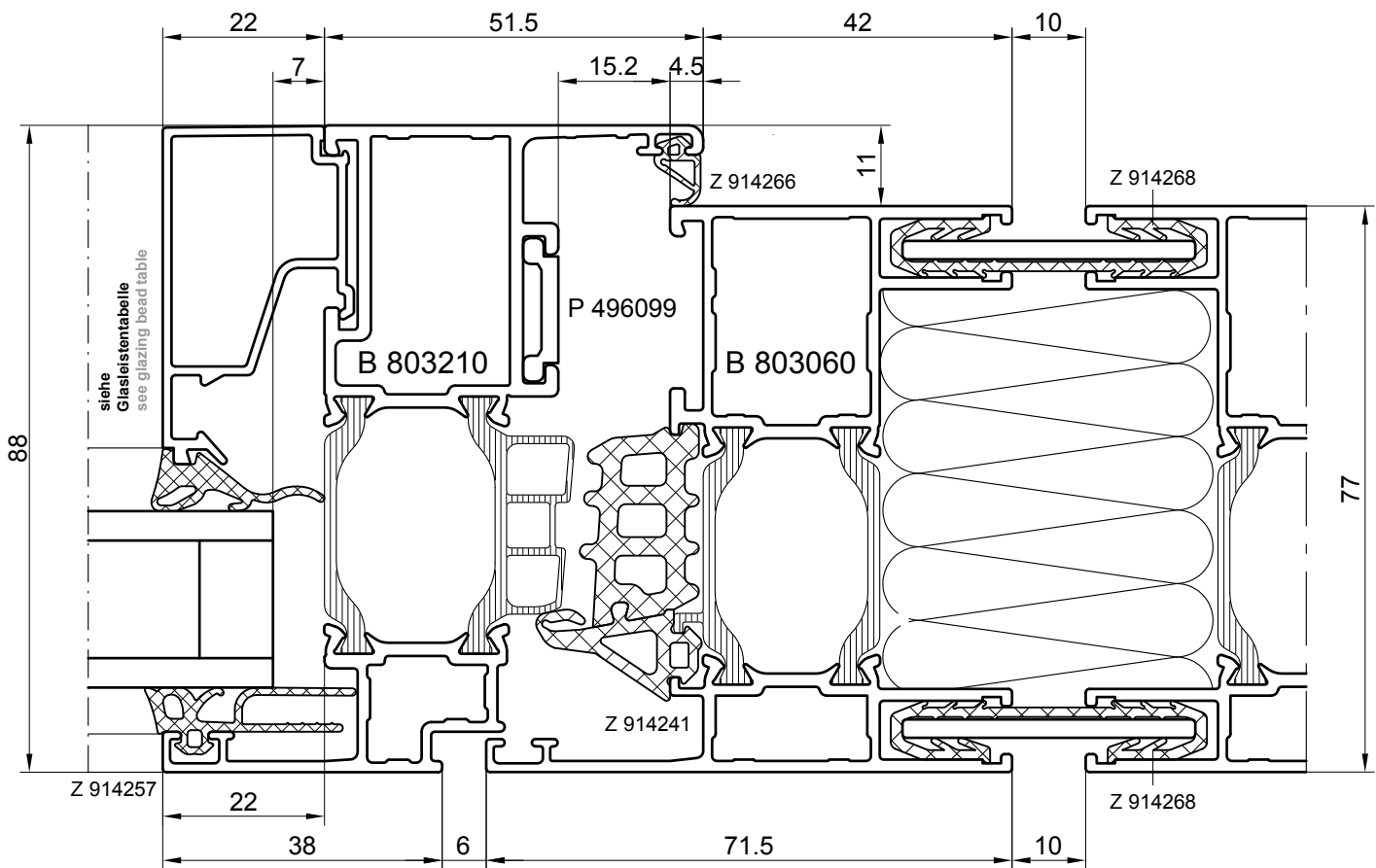
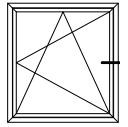

Dichtungen: siehe Register **Zubehör**
Gaskets: refer to register **Accessories**

M 1:1
Scale 1:1

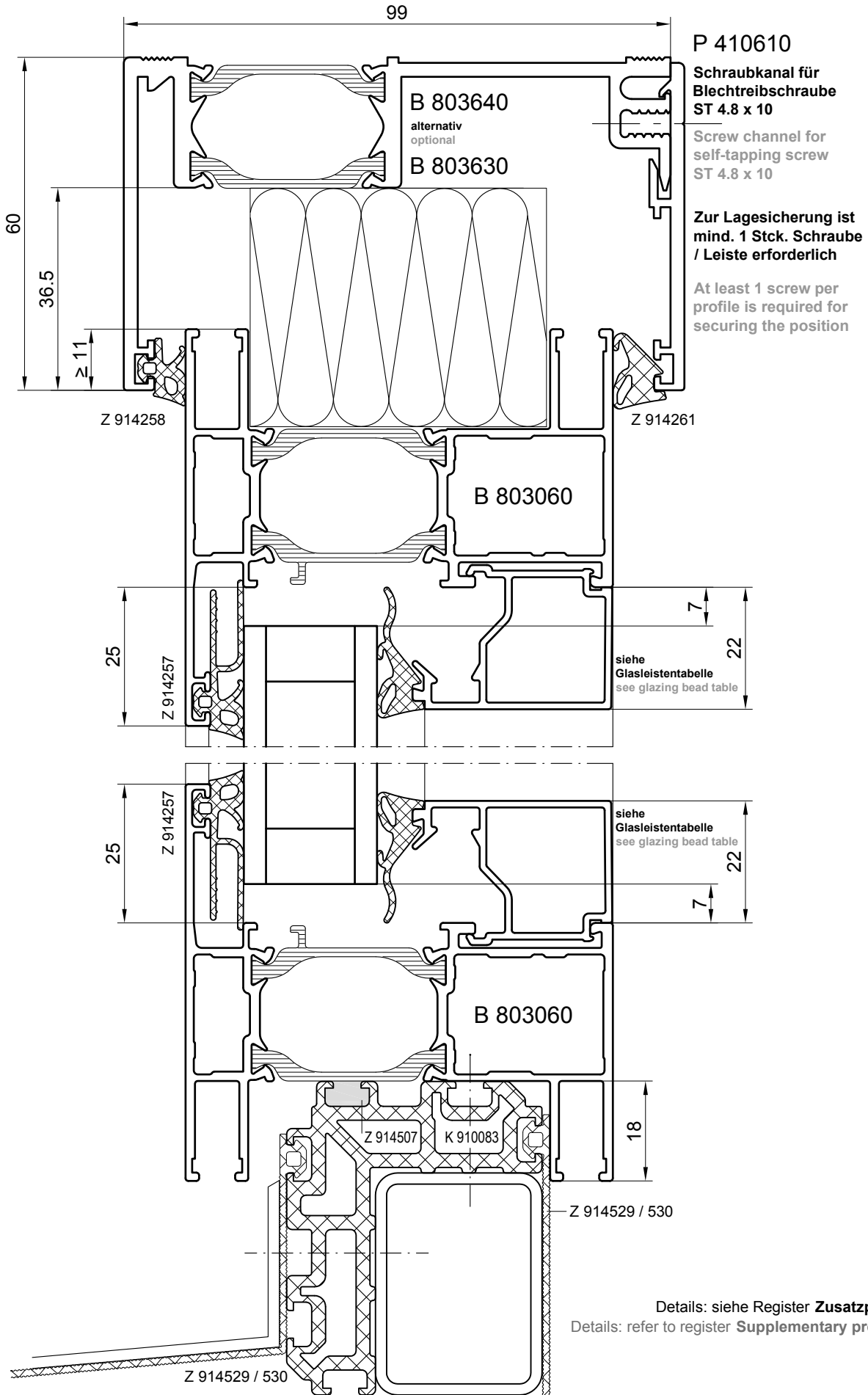
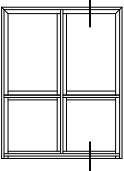

Details: siehe Register **Zusatzprofile / Schnitte**
Details: refer to register **Supplementary profiles / Sections**

M 1:1
Scale 1:1

085001800

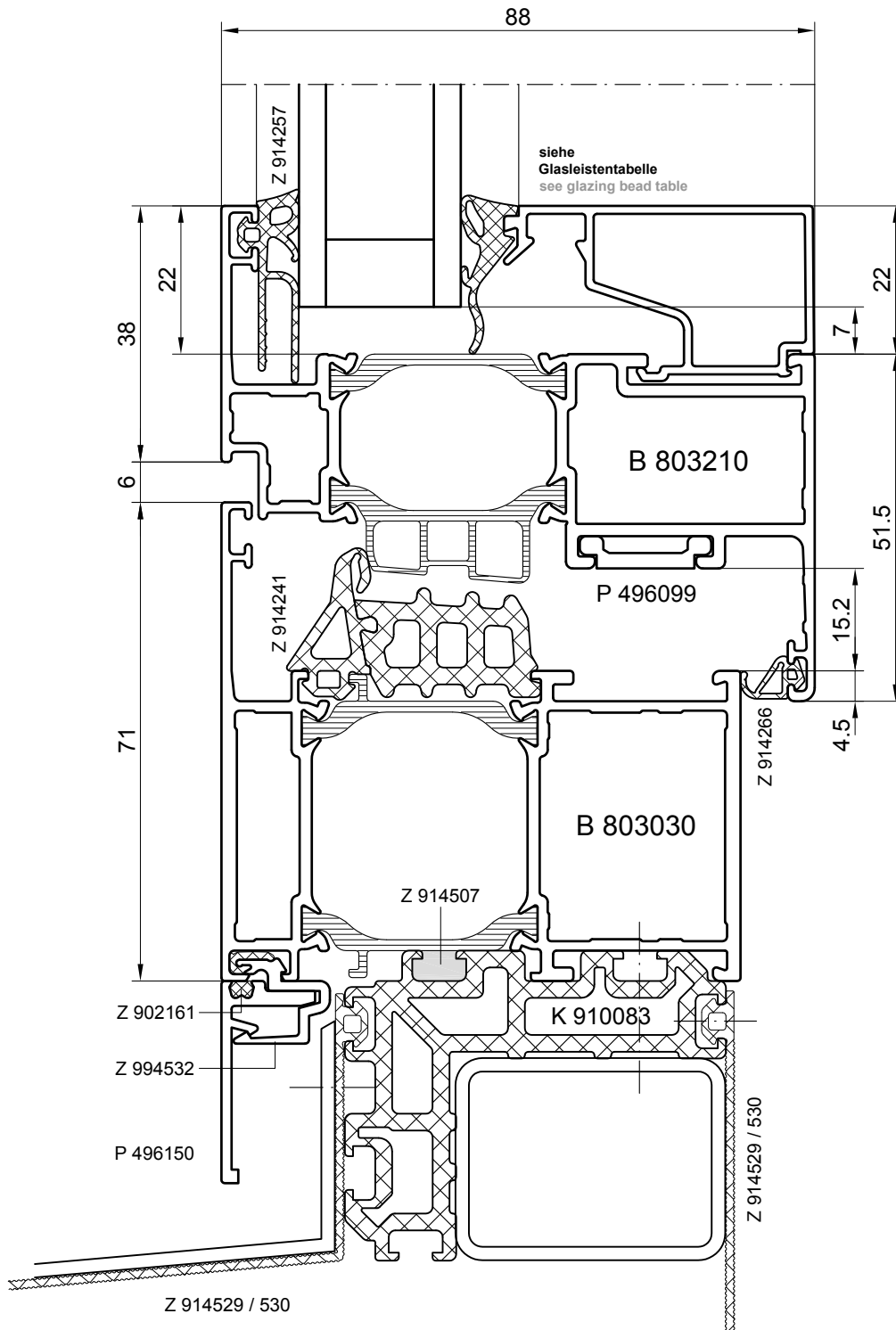
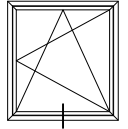

Details: siehe Register **Zusatzprofile / Schnitte**
Details: refer to register **Supplementary profiles / Sections**

086001700

M 1:1
Scale 1:1

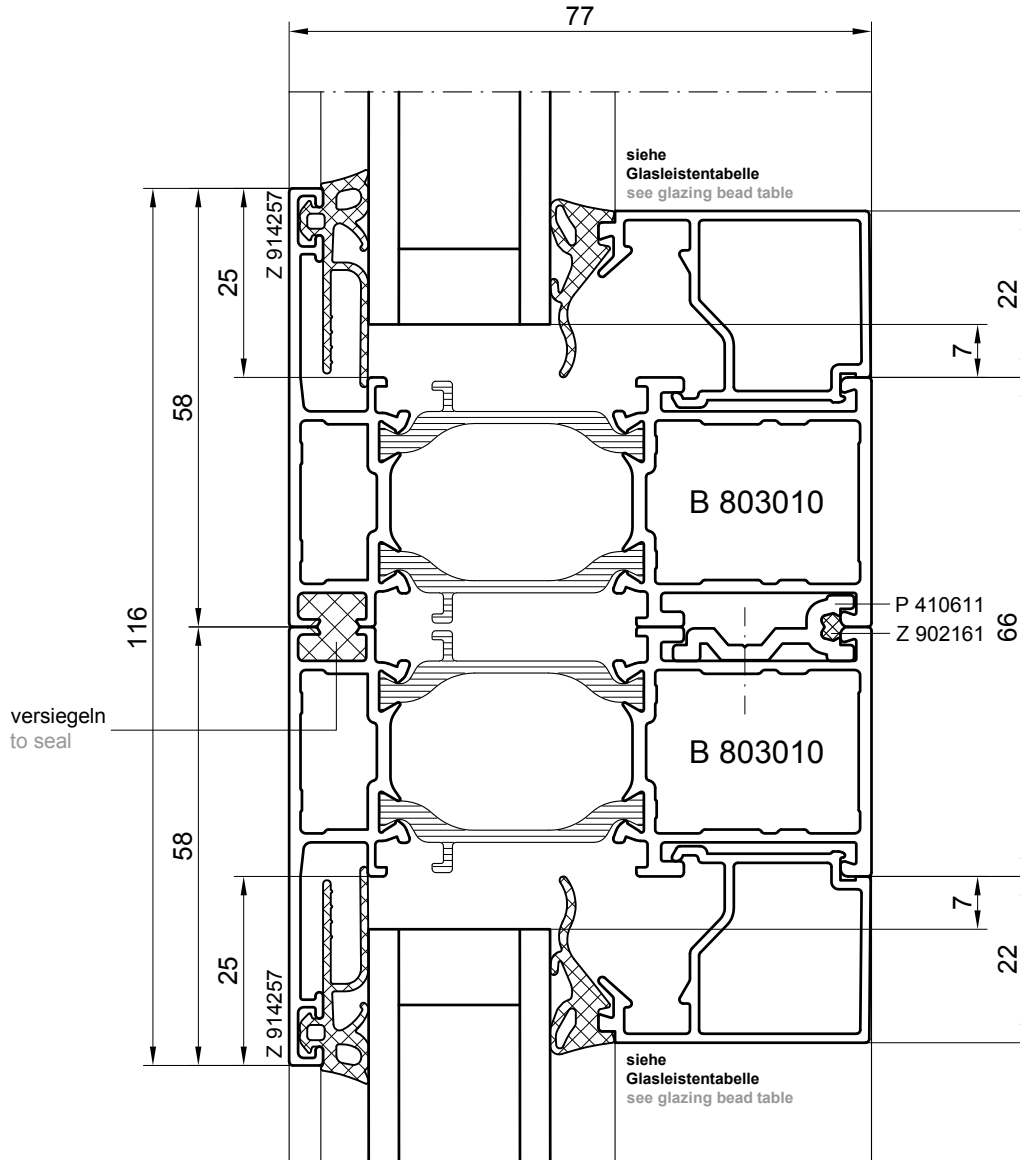
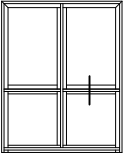

087001800

Dichtungen: siehe Register **Zubehör**
Gaskets: refer to register **Accessories**

M 1:1
Scale 1:1

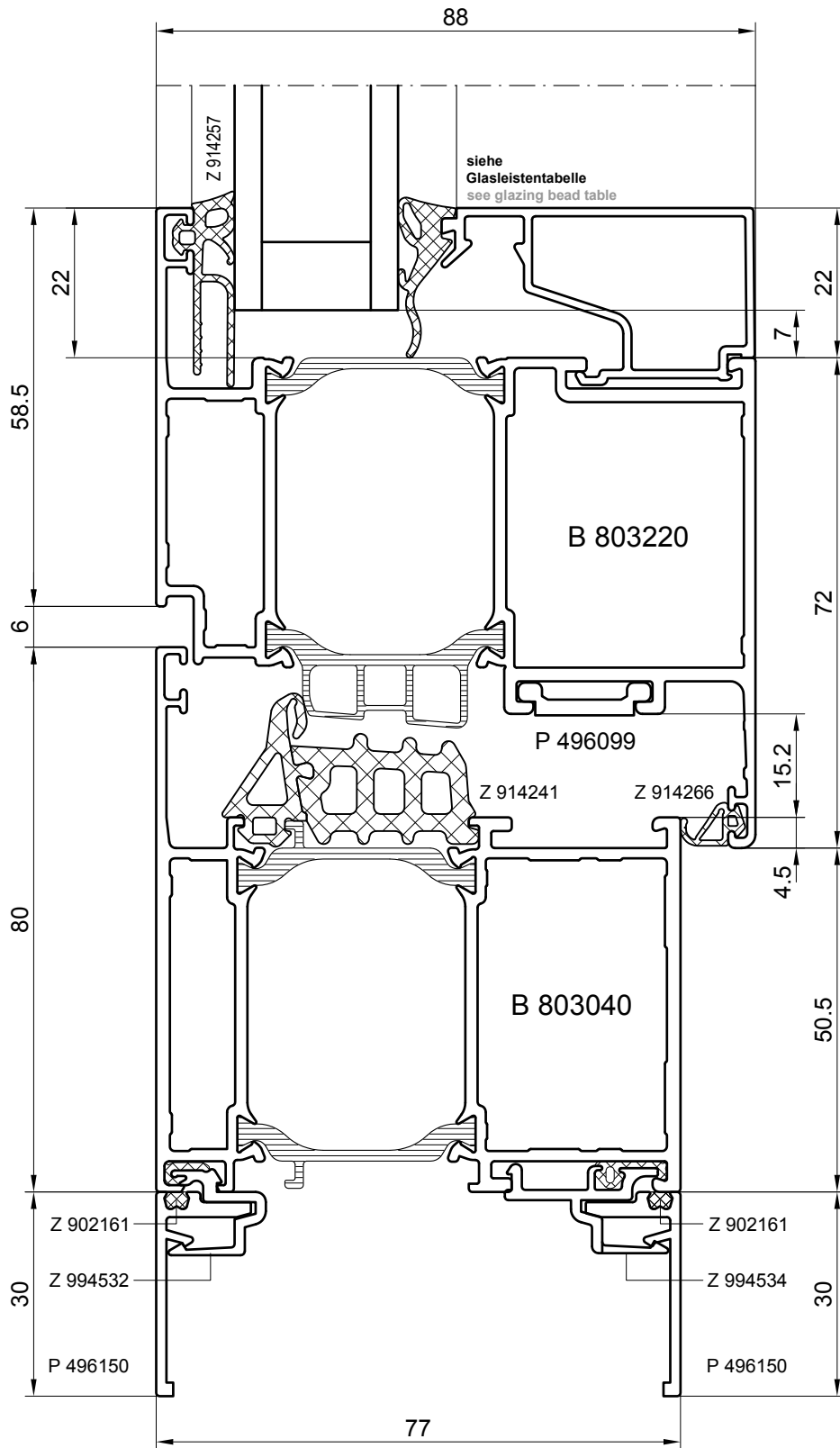
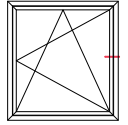

088001900

Dichtungen: siehe Register **Zubehör**
Gaskets: refer to register **Accessories**

M 1:1
Scale 1:1

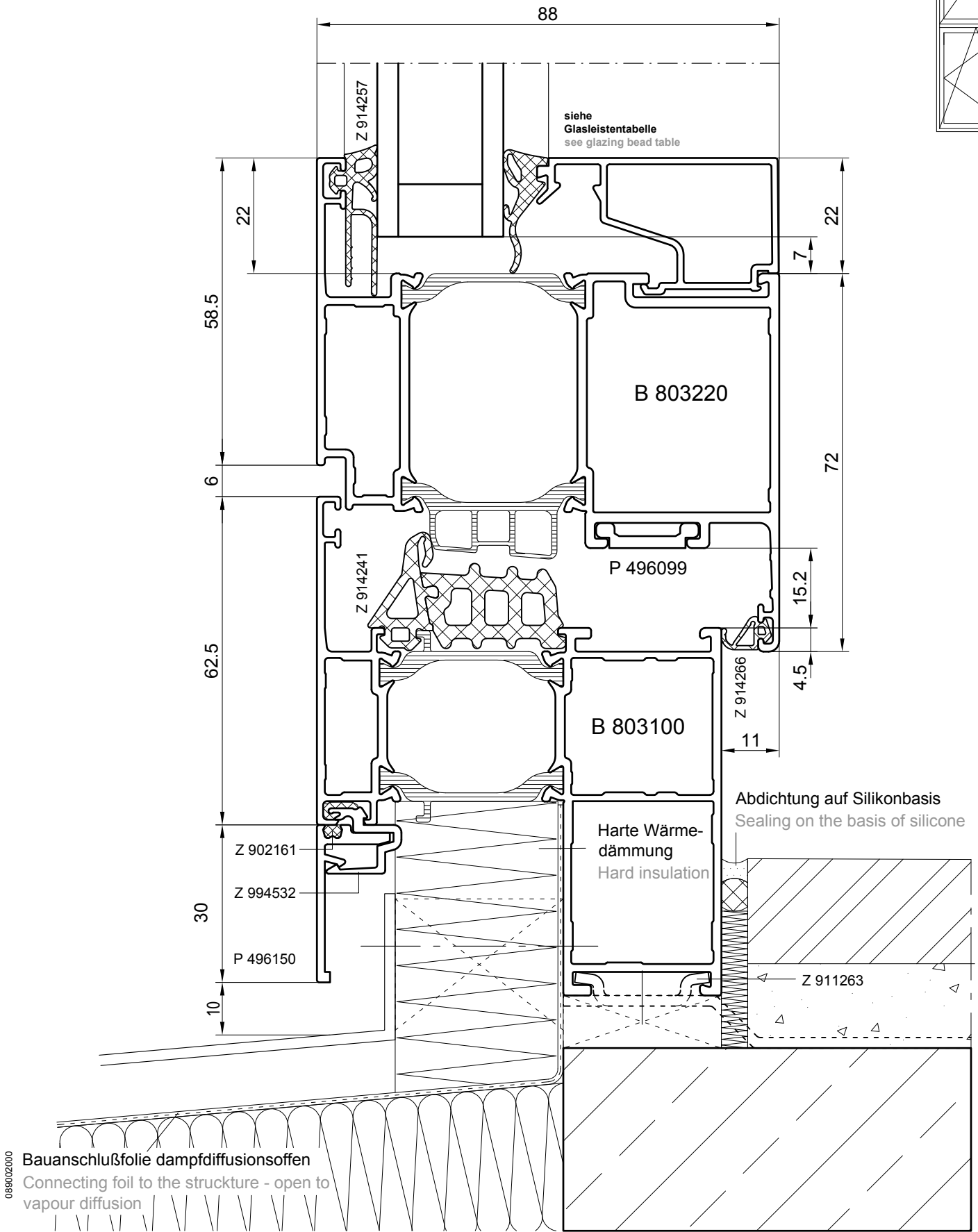
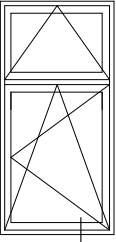

Dichtungen: siehe Register **Zubehör**
Gaskets: refer to register **Accessories**

M 1:1
Scale 1:1

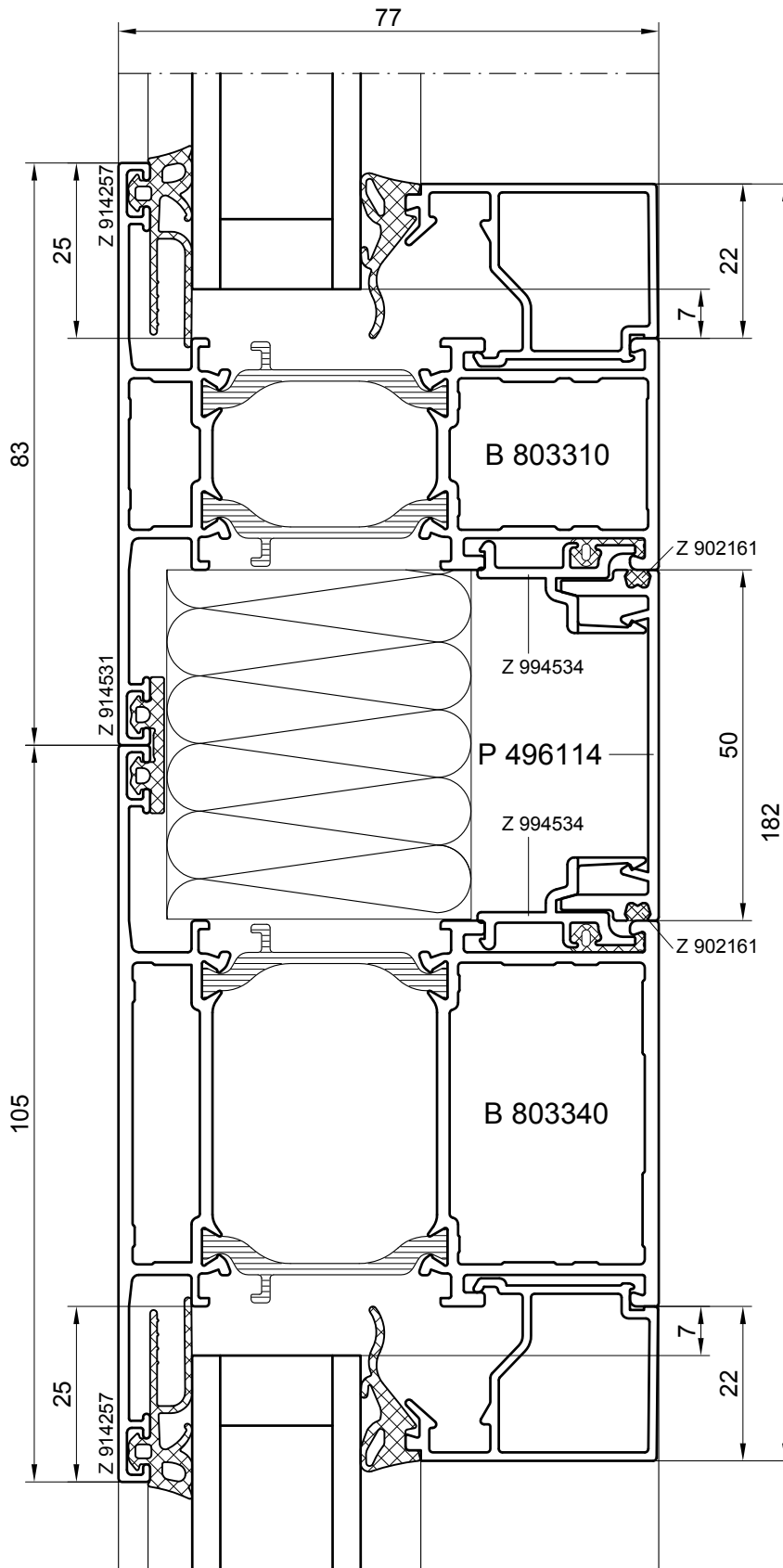
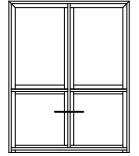

Dichtungen: siehe Register **Zubehör**
Gaskets: refer to register **Accessories**

M 1:1
Scale 1:1

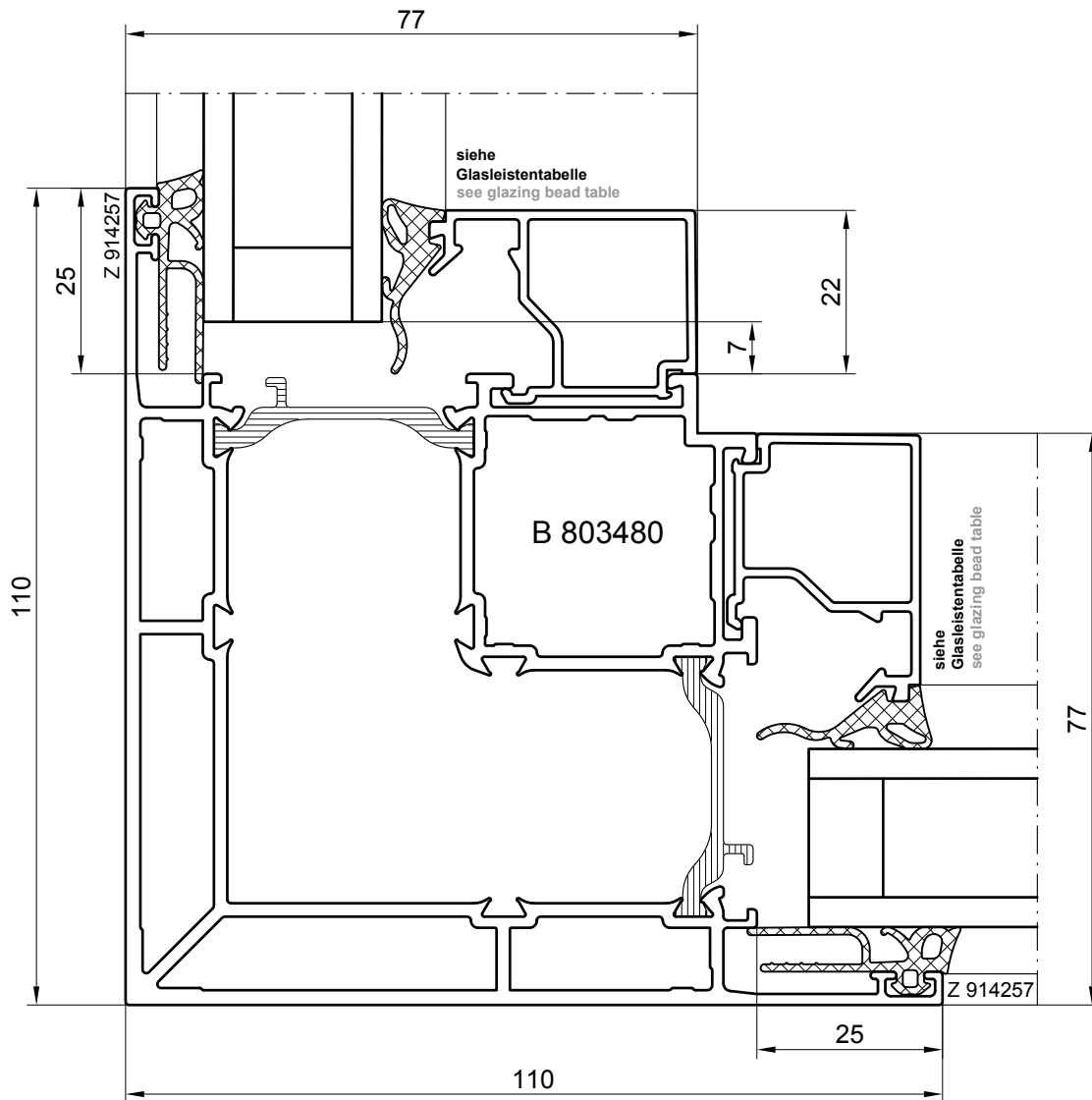

09.10.02200

Dichtungen: siehe Register **Zubehör**
Gaskets: refer to register **Accessories**

M 1:1
Scale 1:1

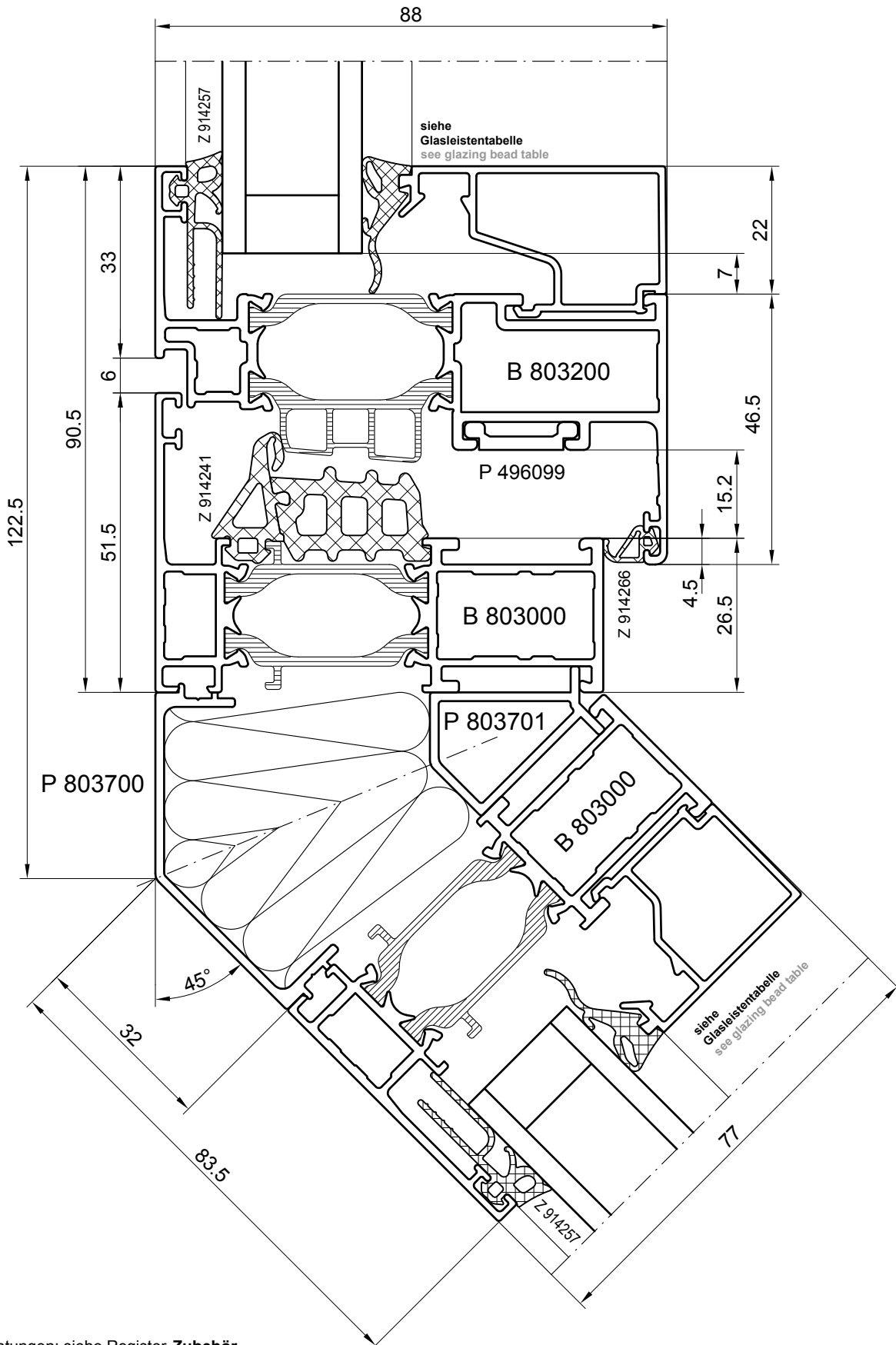

Dichtungen: siehe Register **Zubehör**
Gaskets: refer to register **Accessories**

M 1:1
Scale 1:1

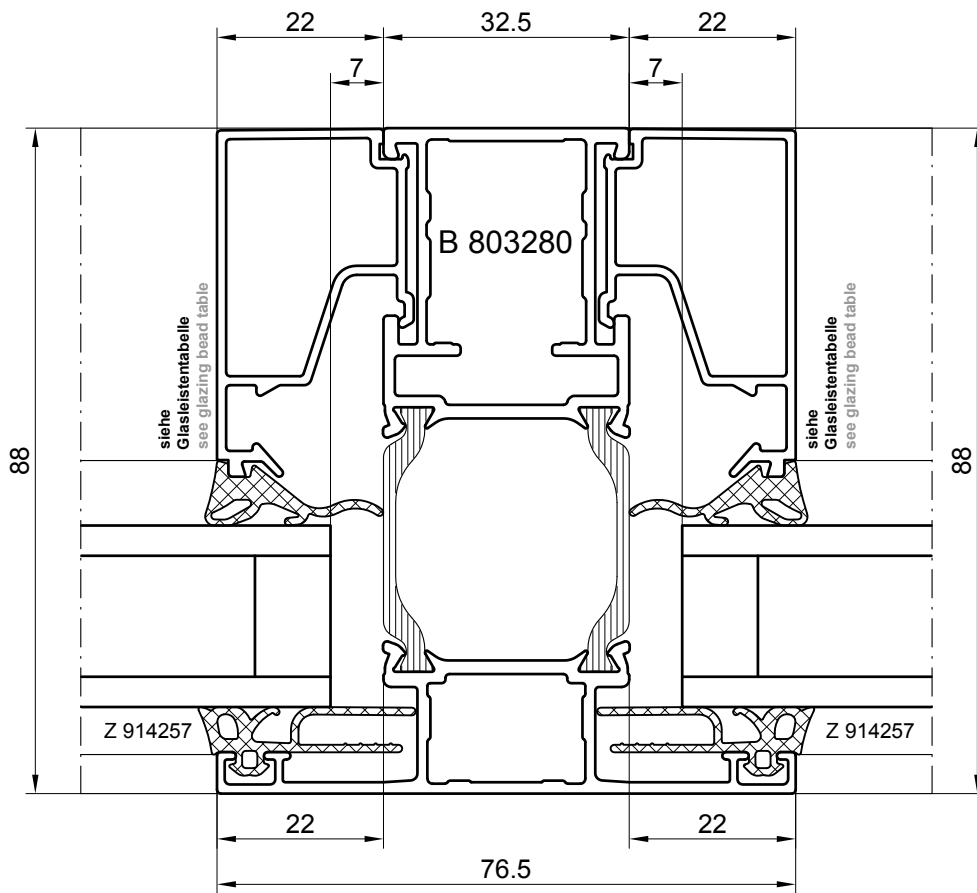
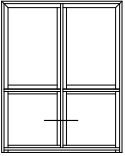

093002400

Dichtungen: siehe Register **Zubehör**
Gaskets: refer to register **Accessories**

M 1:1
Scale 1:1

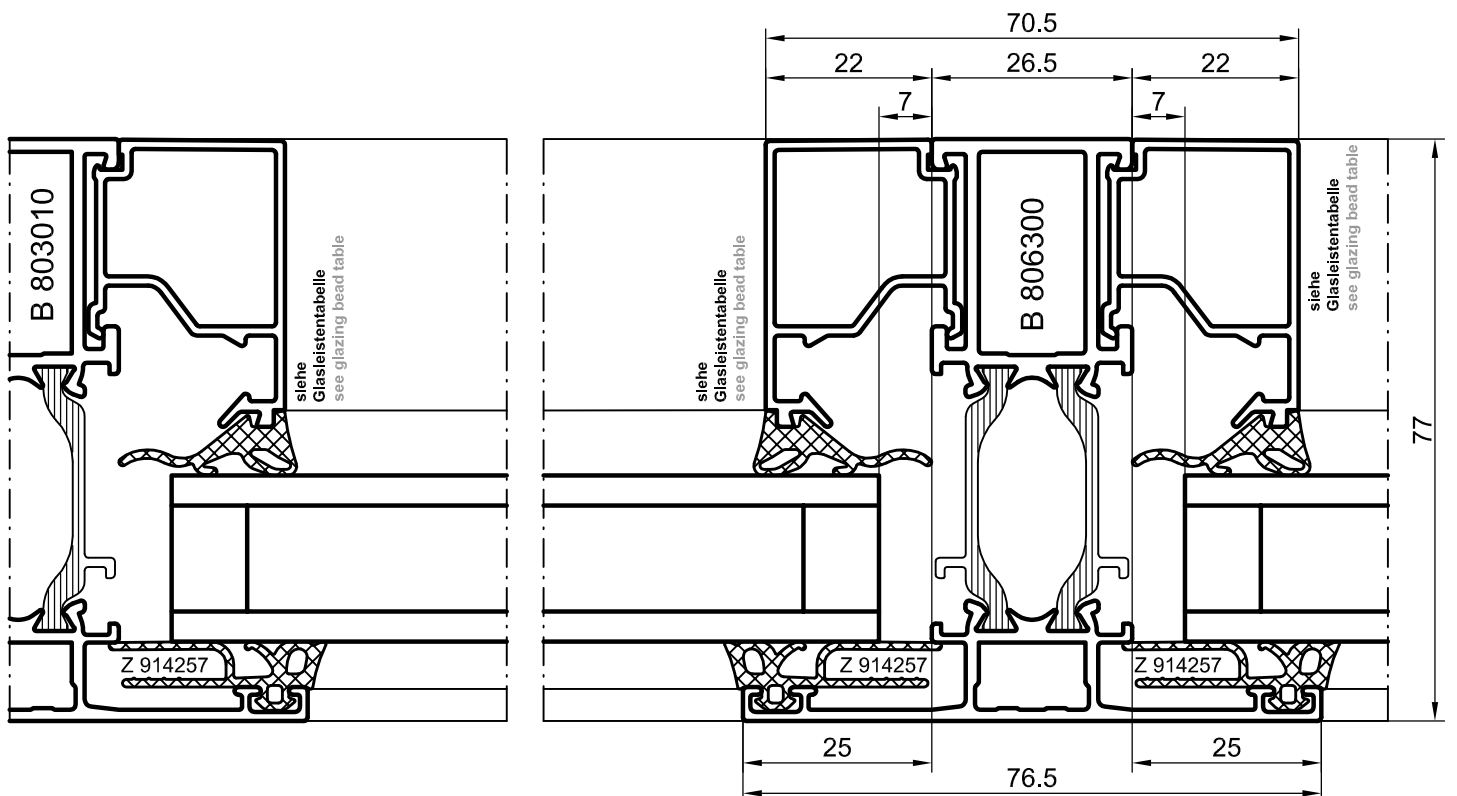
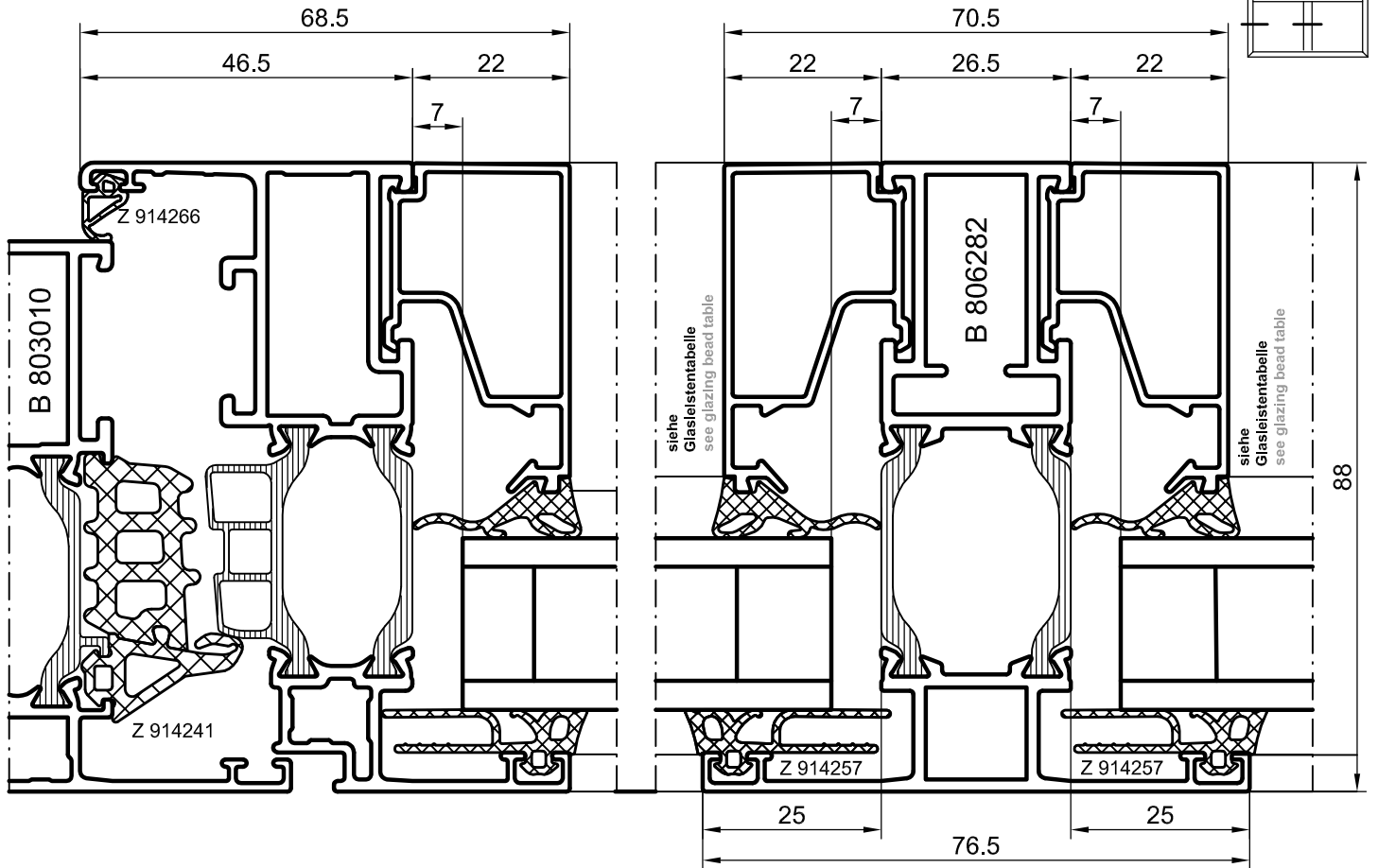
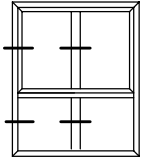

Dichtungen: siehe Register **Zubehör**
Gaskets: refer to register **Accessories**

M 1:1
Scale 1:1

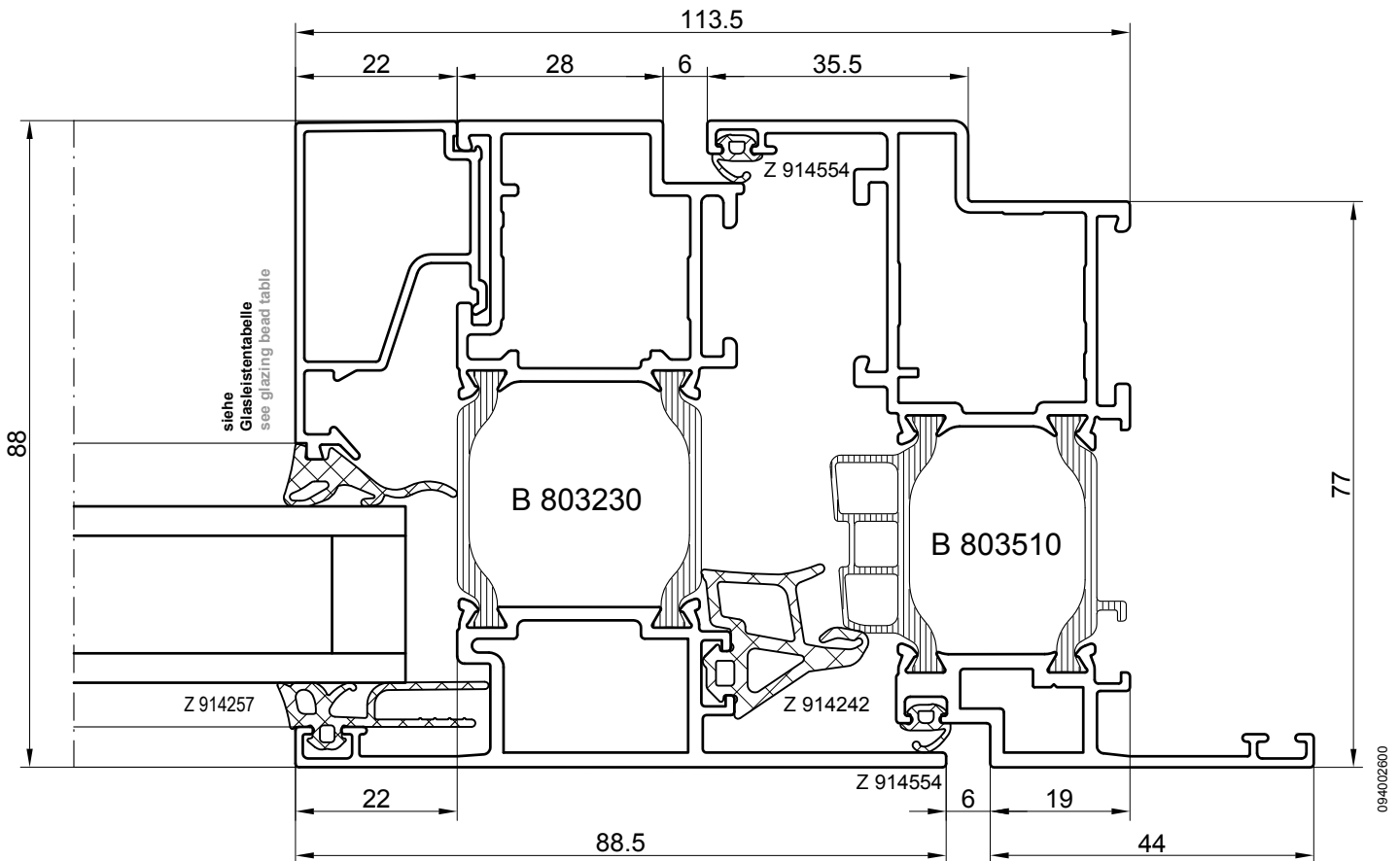
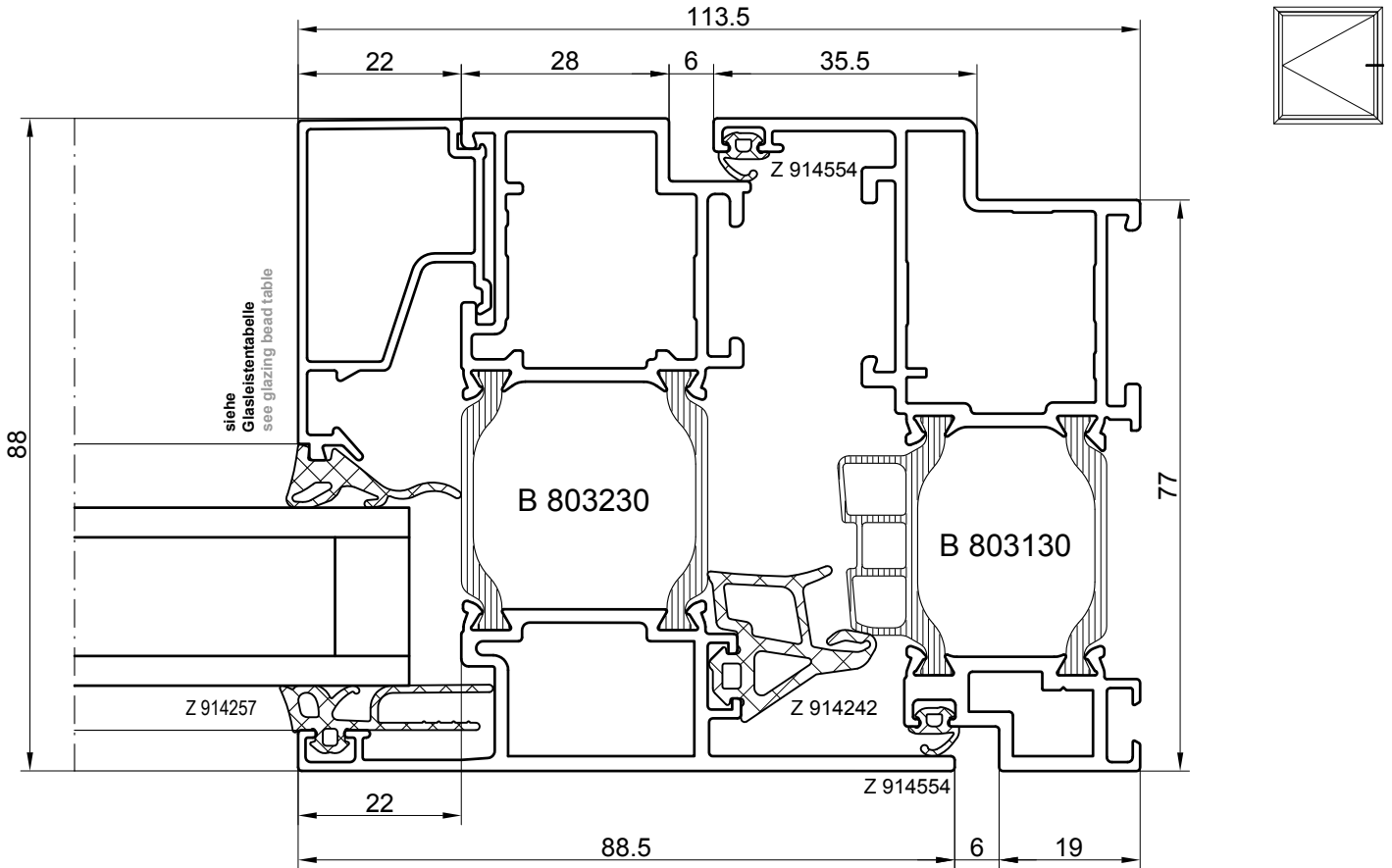

Dichtungen: siehe Register **Zubehör**
Gaskets: refer to register **Accessories**

M 1:1
Scale 1:1

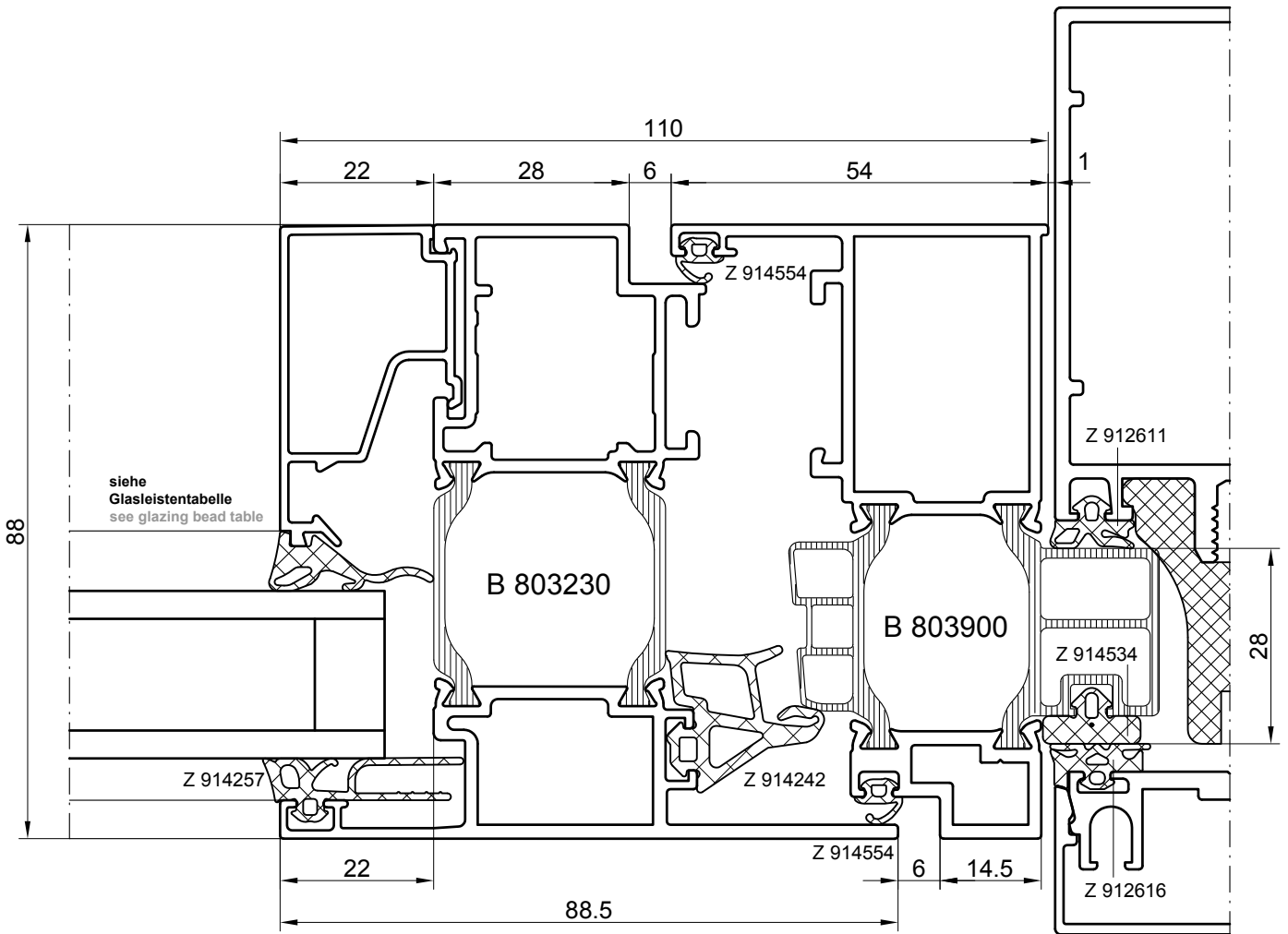
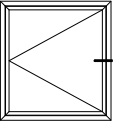

095003100

Dichtungen: siehe Register **Zubehör**
Gaskets: refer to register **Accessories**

M 1:1
Scale 1:1

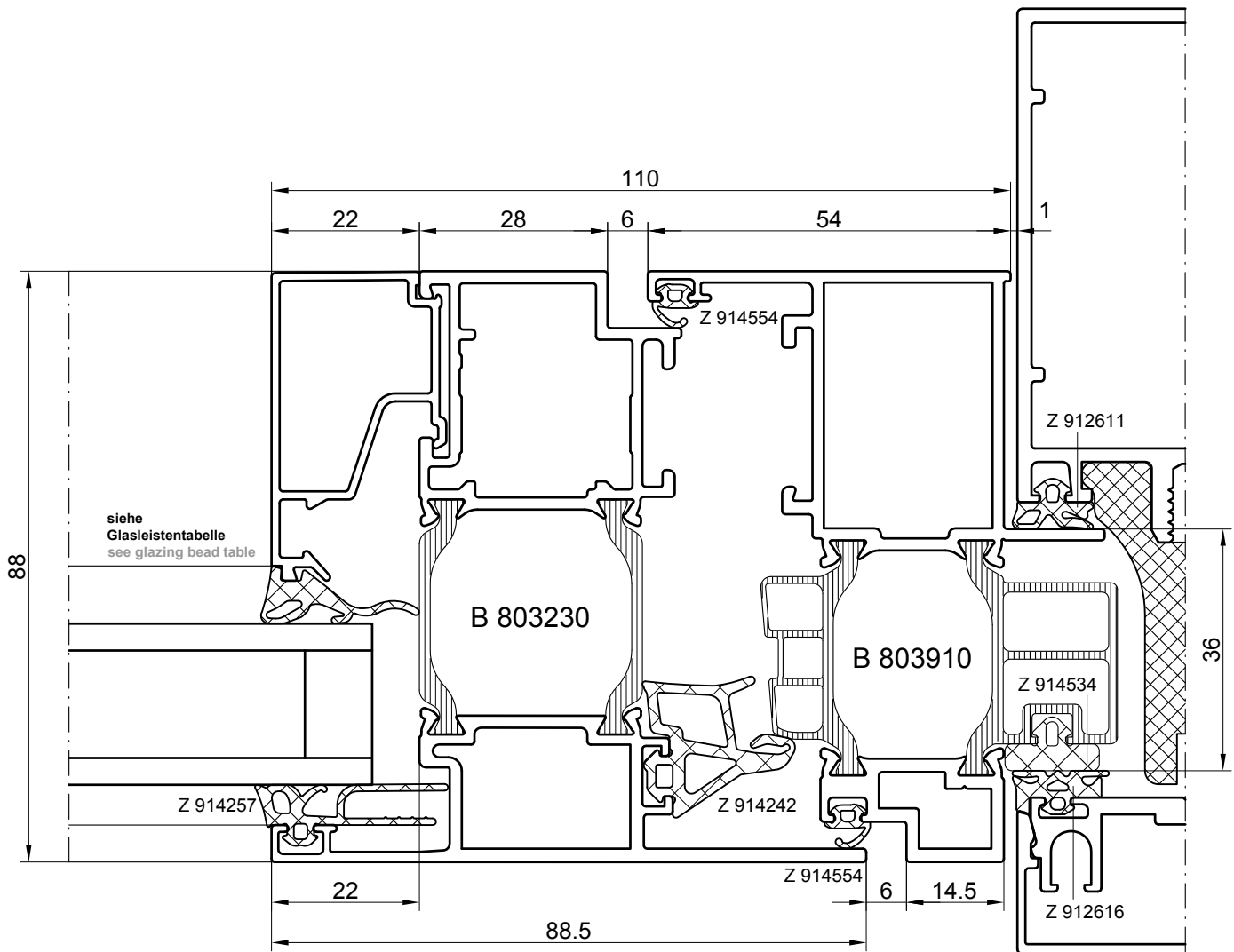
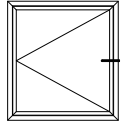

Dichtungen: siehe Register **Zubehör**
Gaskets: refer to register **Accessories**

M 1:1
Scale 1:1

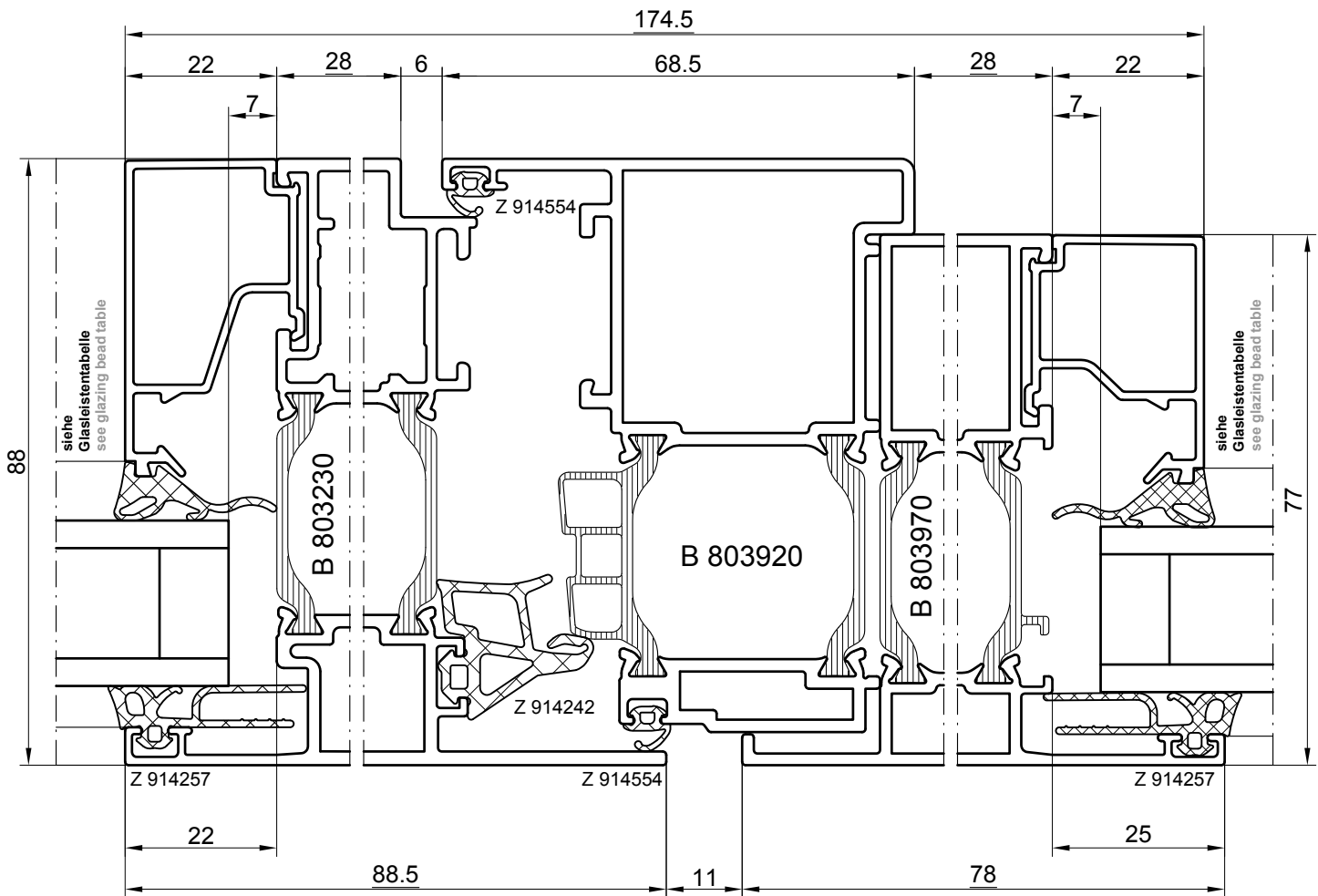
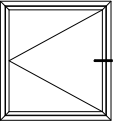

097003300

Dichtungen: siehe Register **Zubehör**
Gaskets: refer to register **Accessories**

M 1:1
Scale 1:1

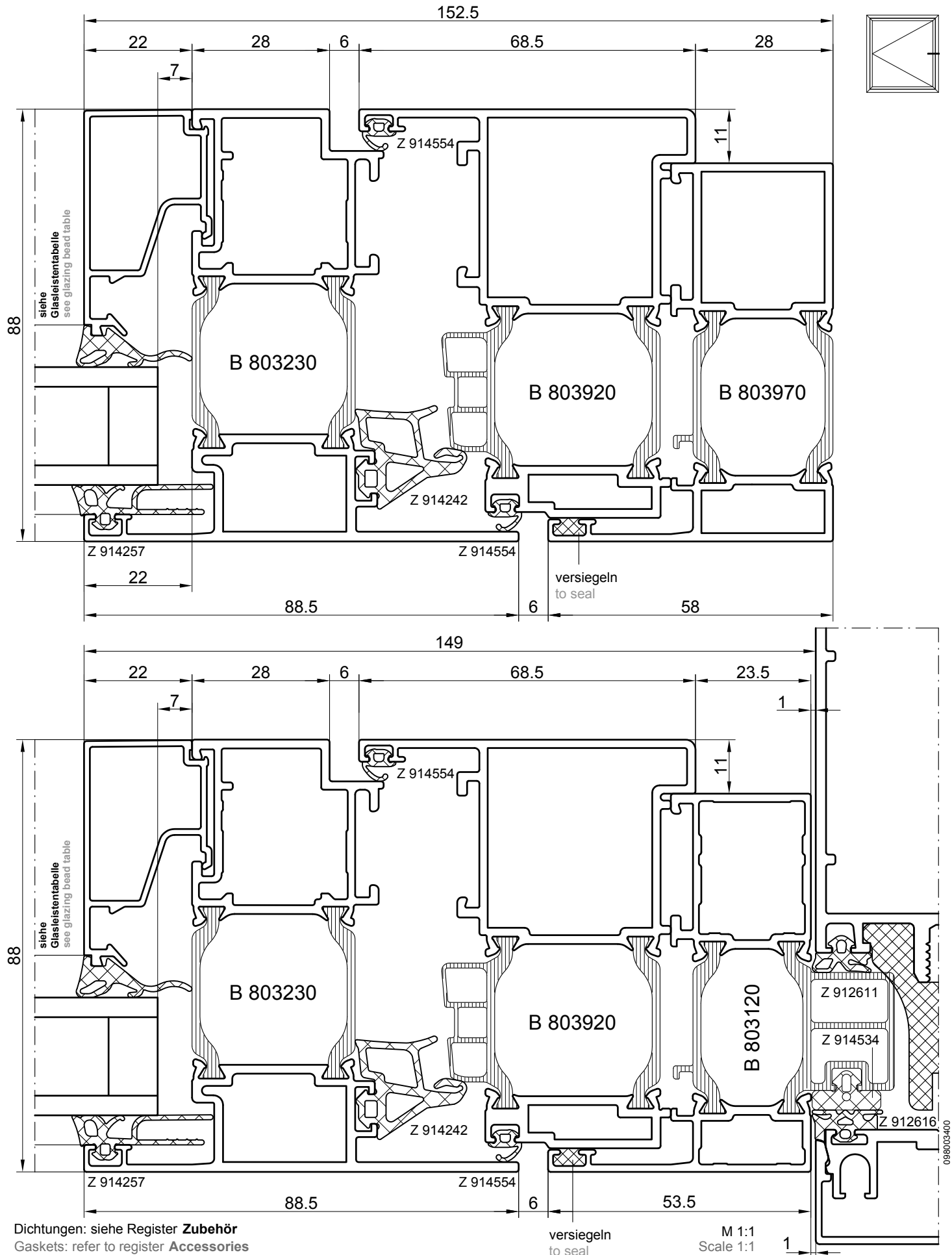

Dichtungen: siehe Register **Zubehör**
Gaskets: refer to register **Accessories**

versiegeln
to seal

M 1:1
Scale 1:1