

023000100

Dichtungen: siehe Register **Zubehör**
Gaskets: refer to register **Accessories**

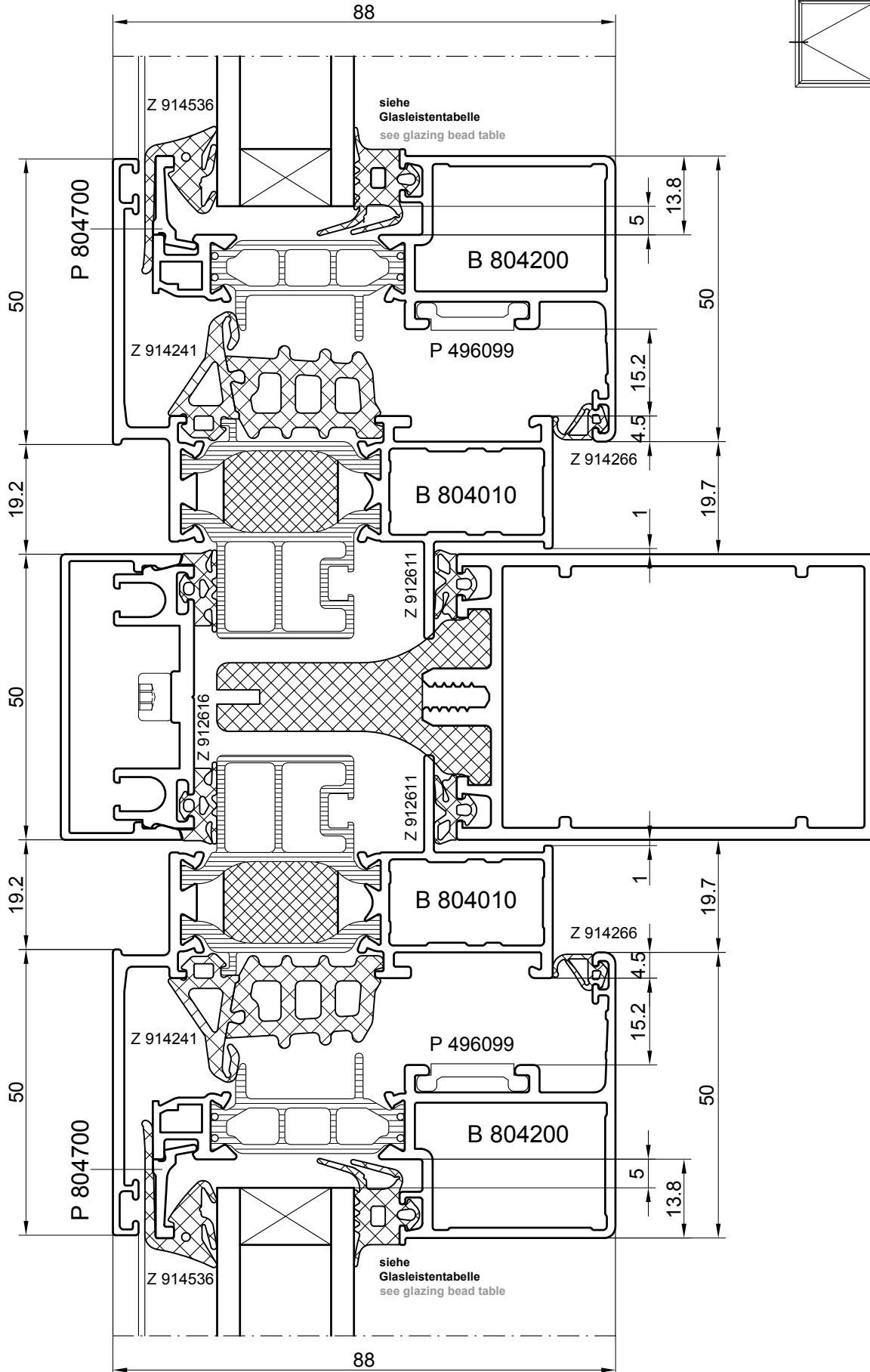

Dichtungen: siehe Register **Zubehör**
Gaskets: refer to register **Accessories**

M 1:1
Scale 1:1

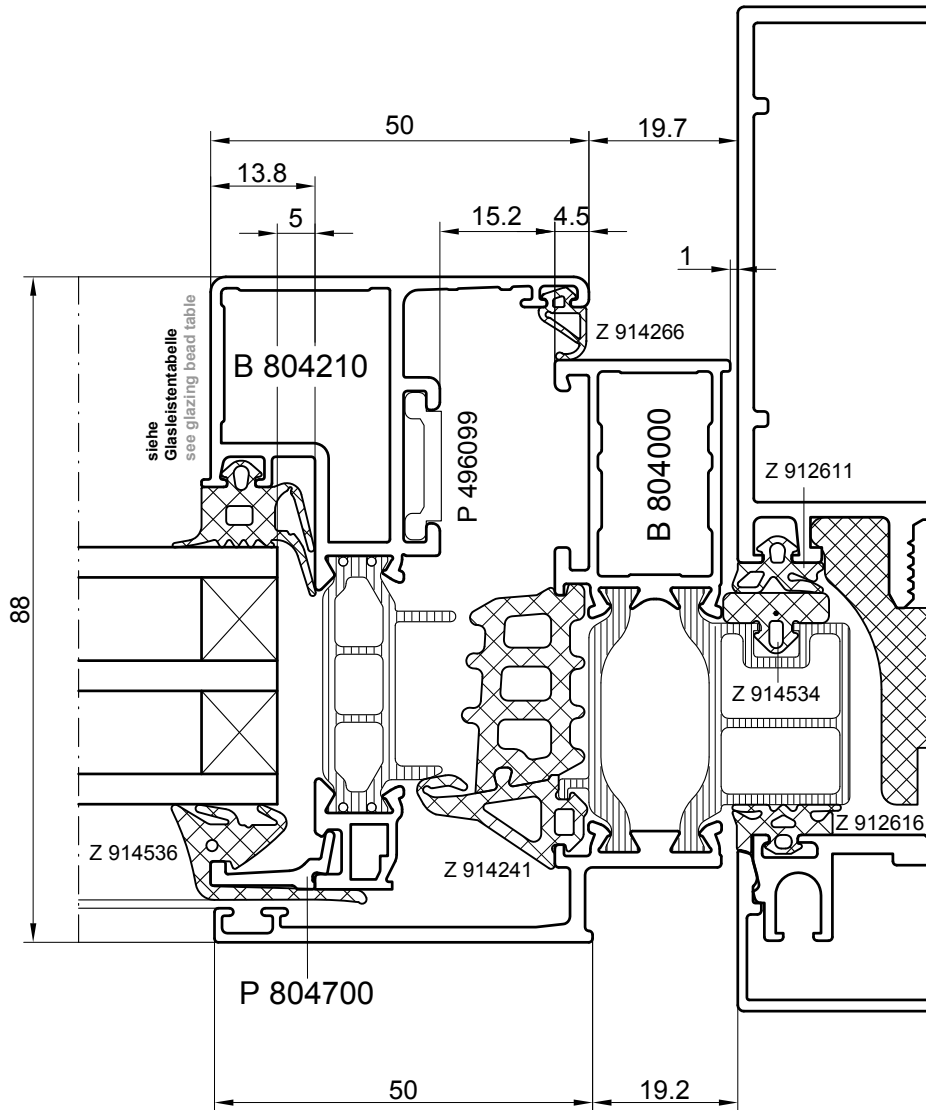
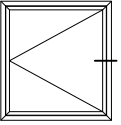

025000300

Dichtungen: siehe Register **Zubehör**
Gaskets: refer to register **Accessories**

M 1:1
Scale 1:1

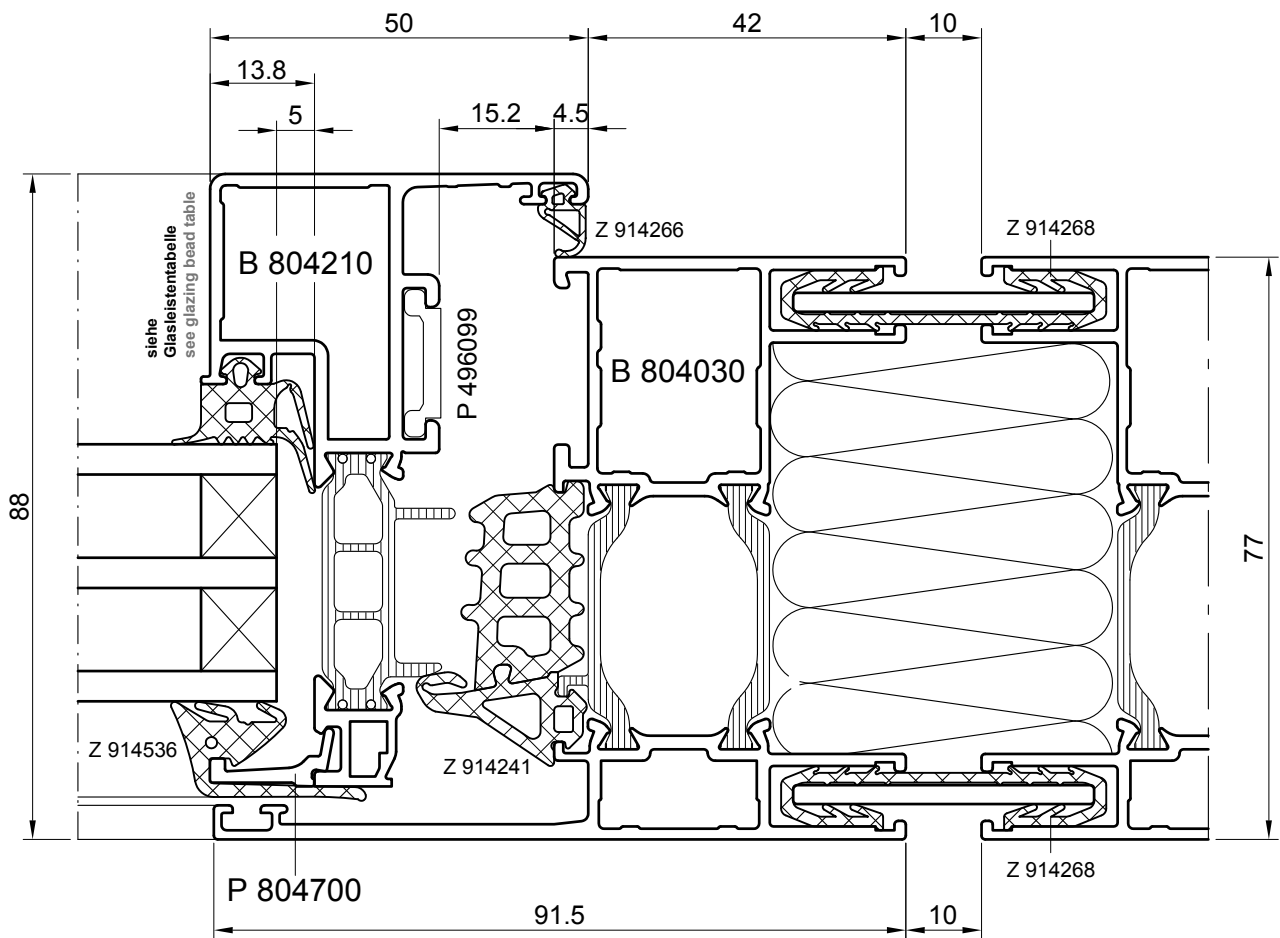
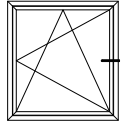

Dichtungen: siehe Register **Zubehör**
Gaskets: refer to register **Accessories**

M 1:1
Scale 1:1

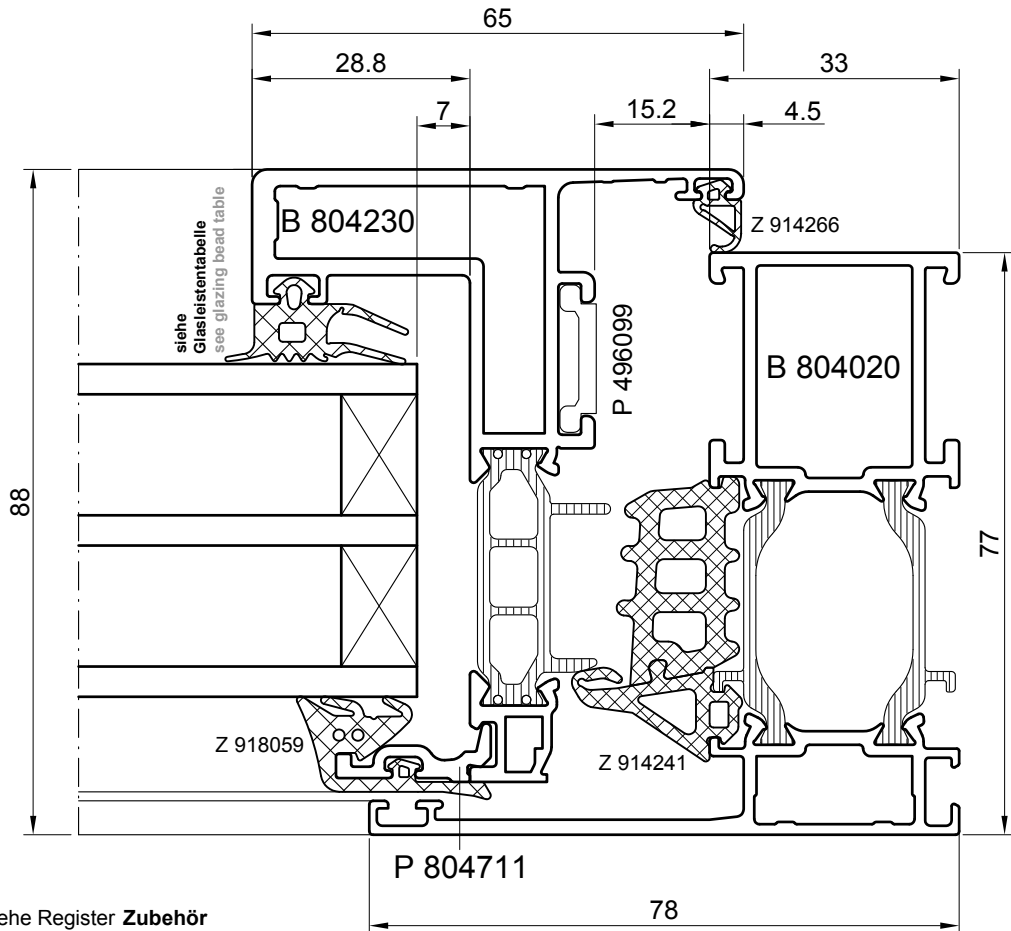
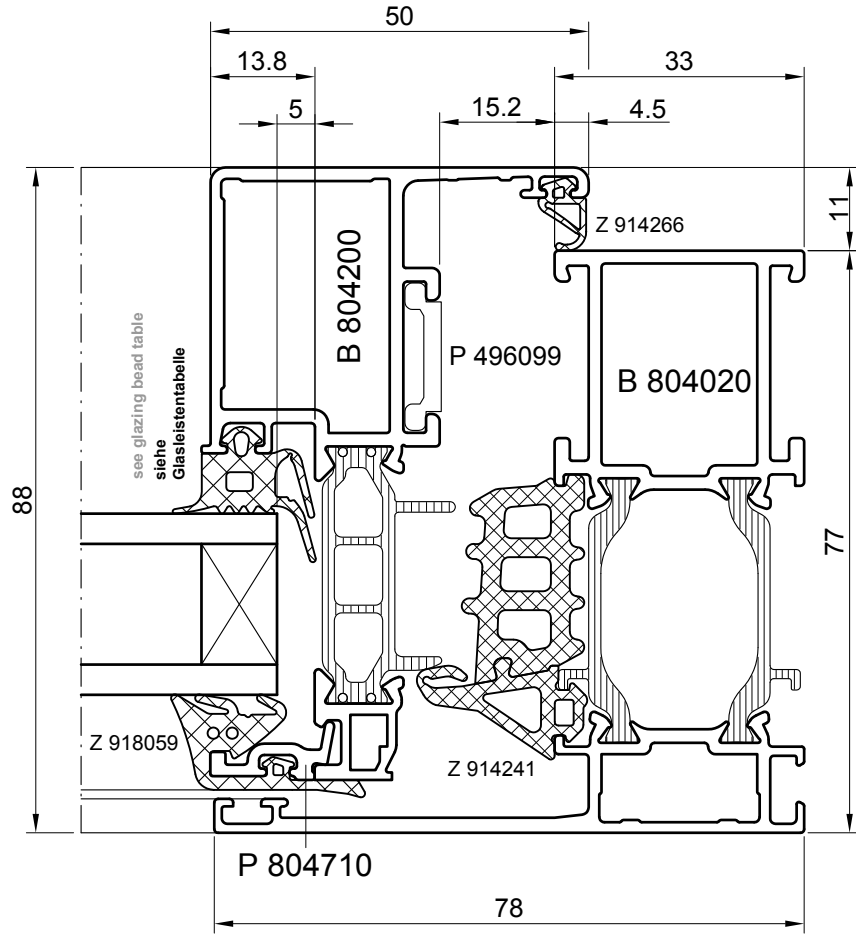
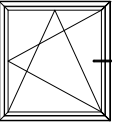

029000900

Dichtungen: siehe Register **Zubehör**
Gaskets: refer to register **Accessories**

M 1:1
Scale 1:1

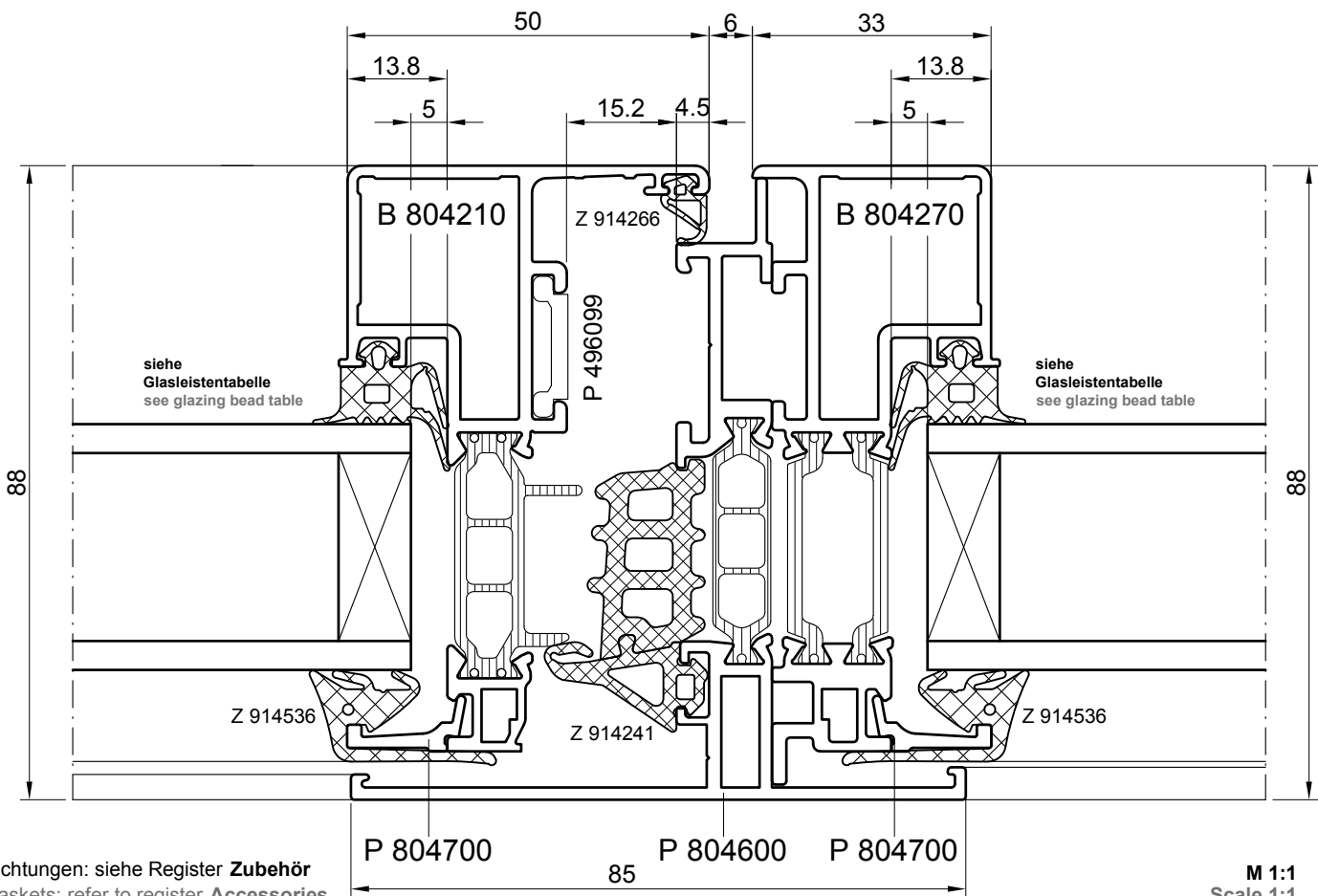
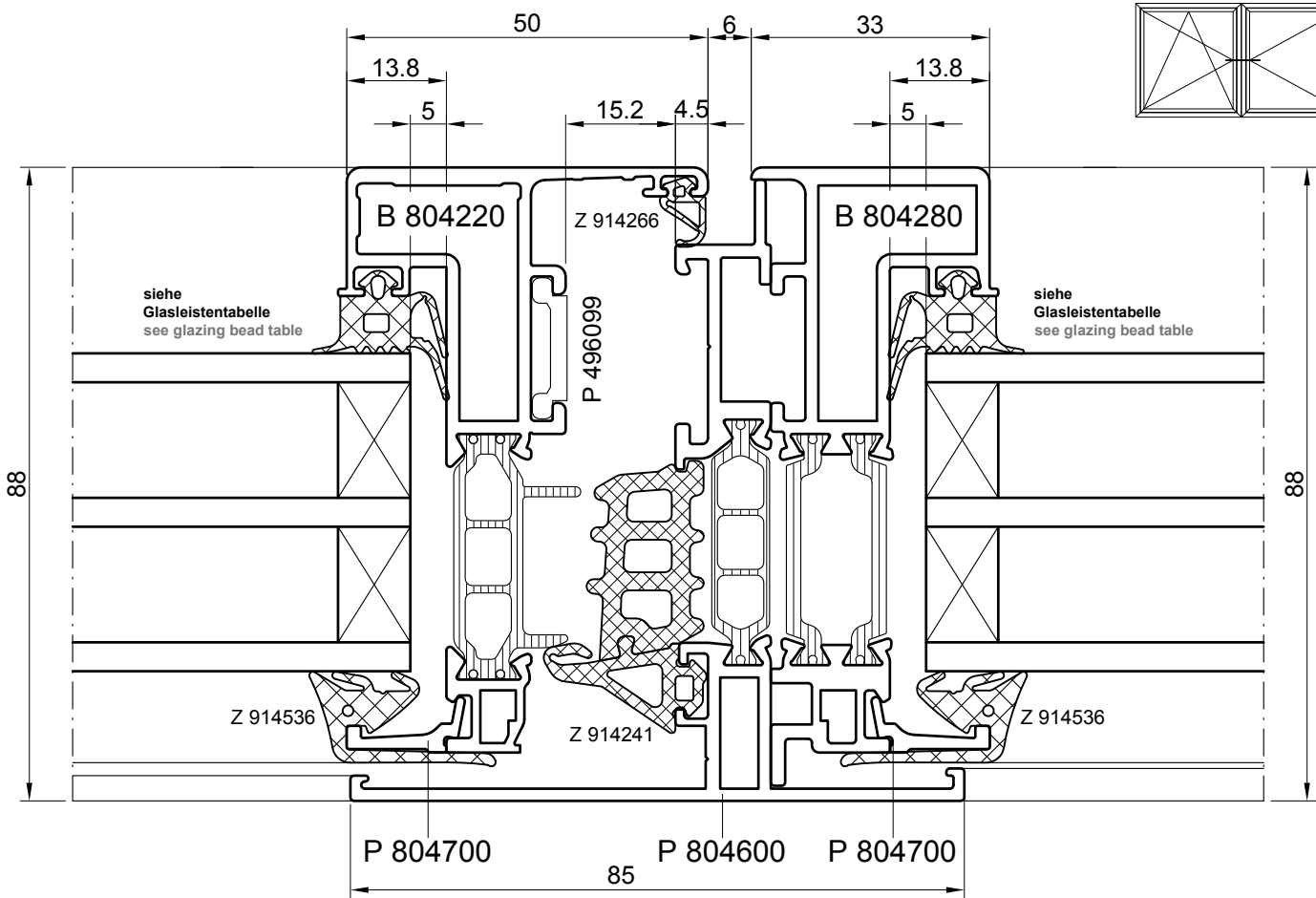

Dichtungen: siehe Register **Zubehör**
Gaskets: refer to register **Accessories**

M 1:1
Scale 1:1

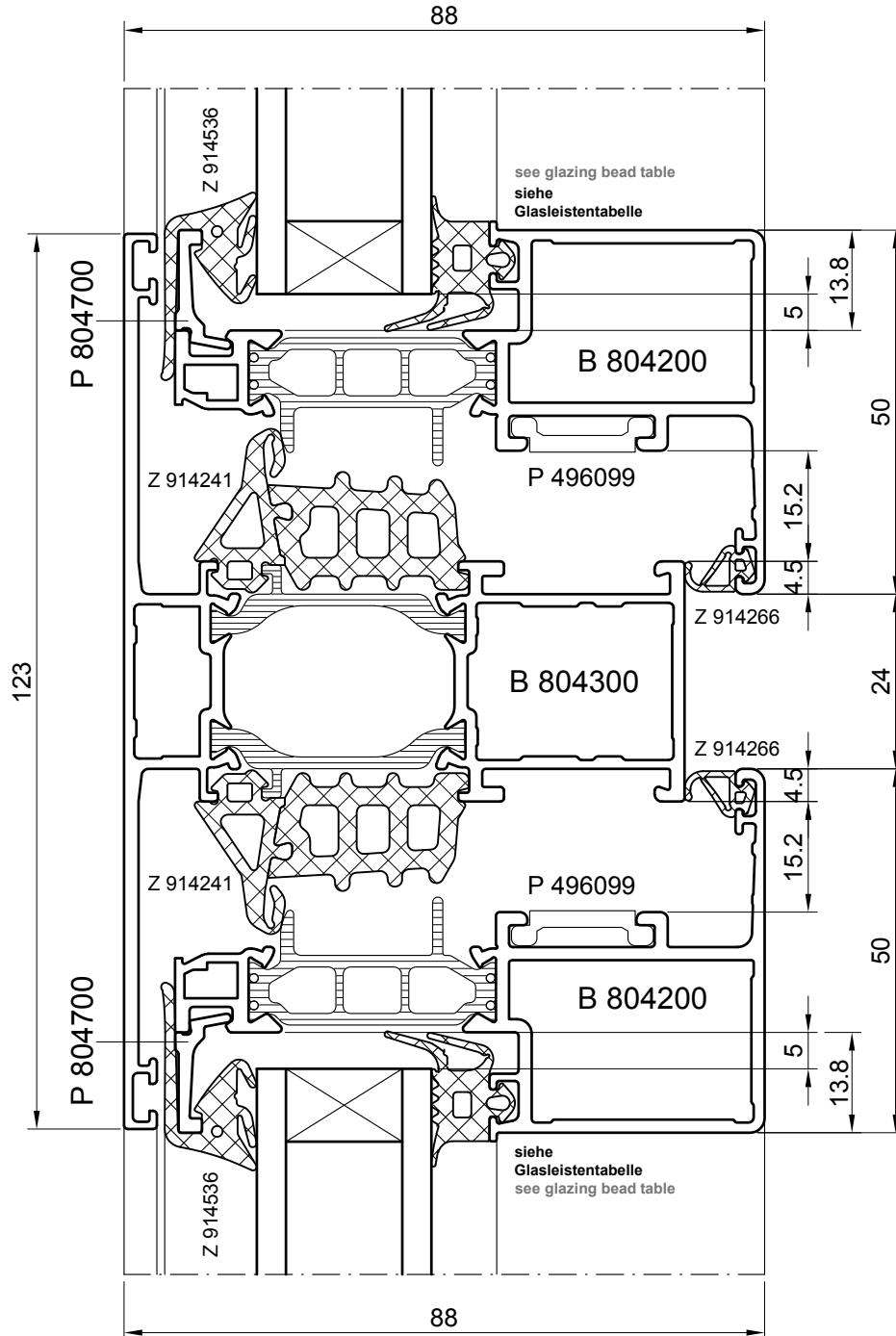
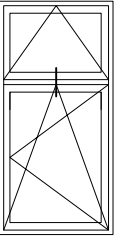

028000500

Dichtungen: siehe Register **Zubehör**
Gaskets: refer to register **Accessories**

M 1:1
Scale 1:1

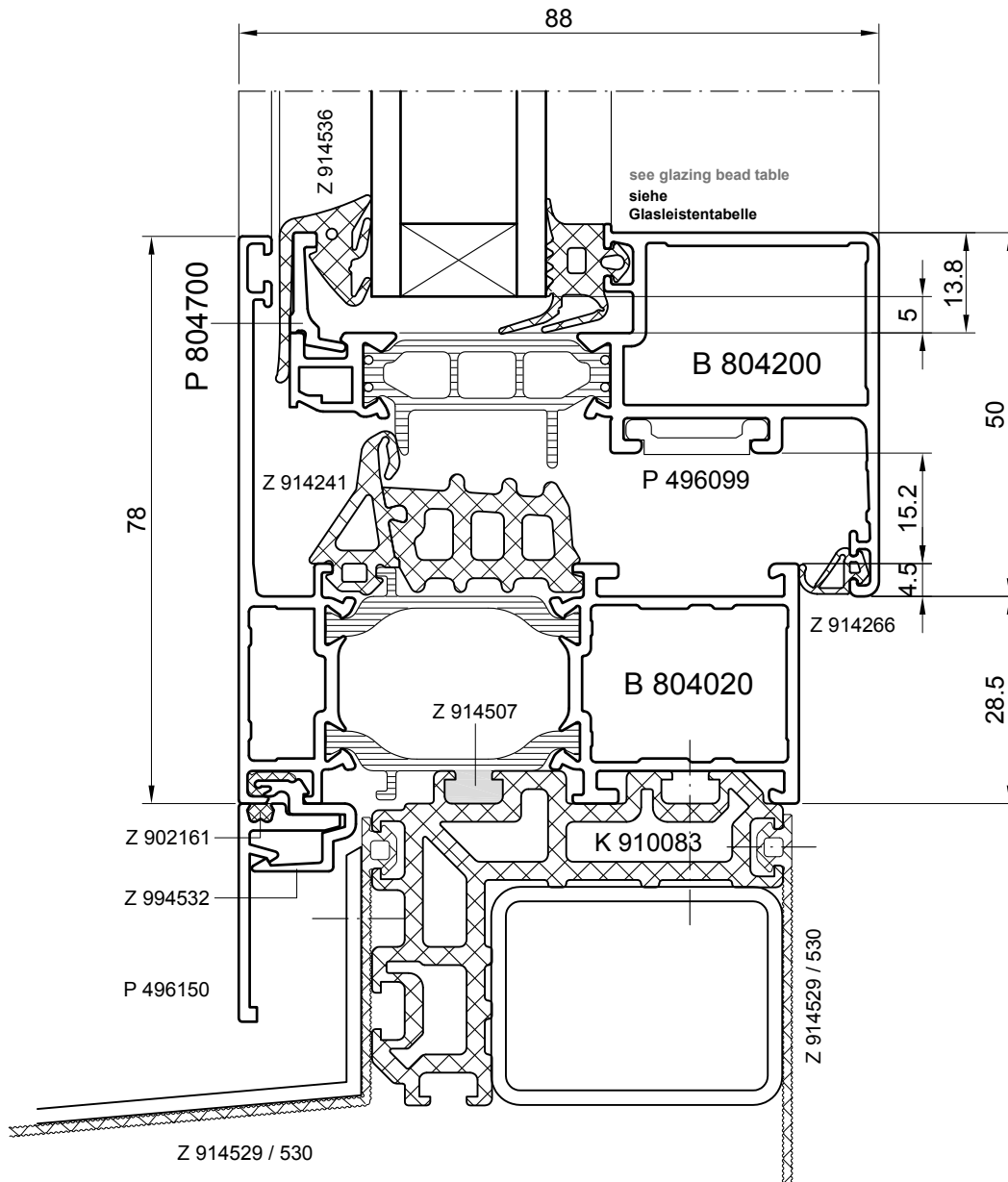
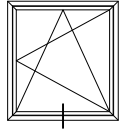

Details: siehe Register **Zusatzprofile / Schnitte**
Details: refer to register **Supplementary profiles / Sections**

030000600

M 1:1
Scale 1:1

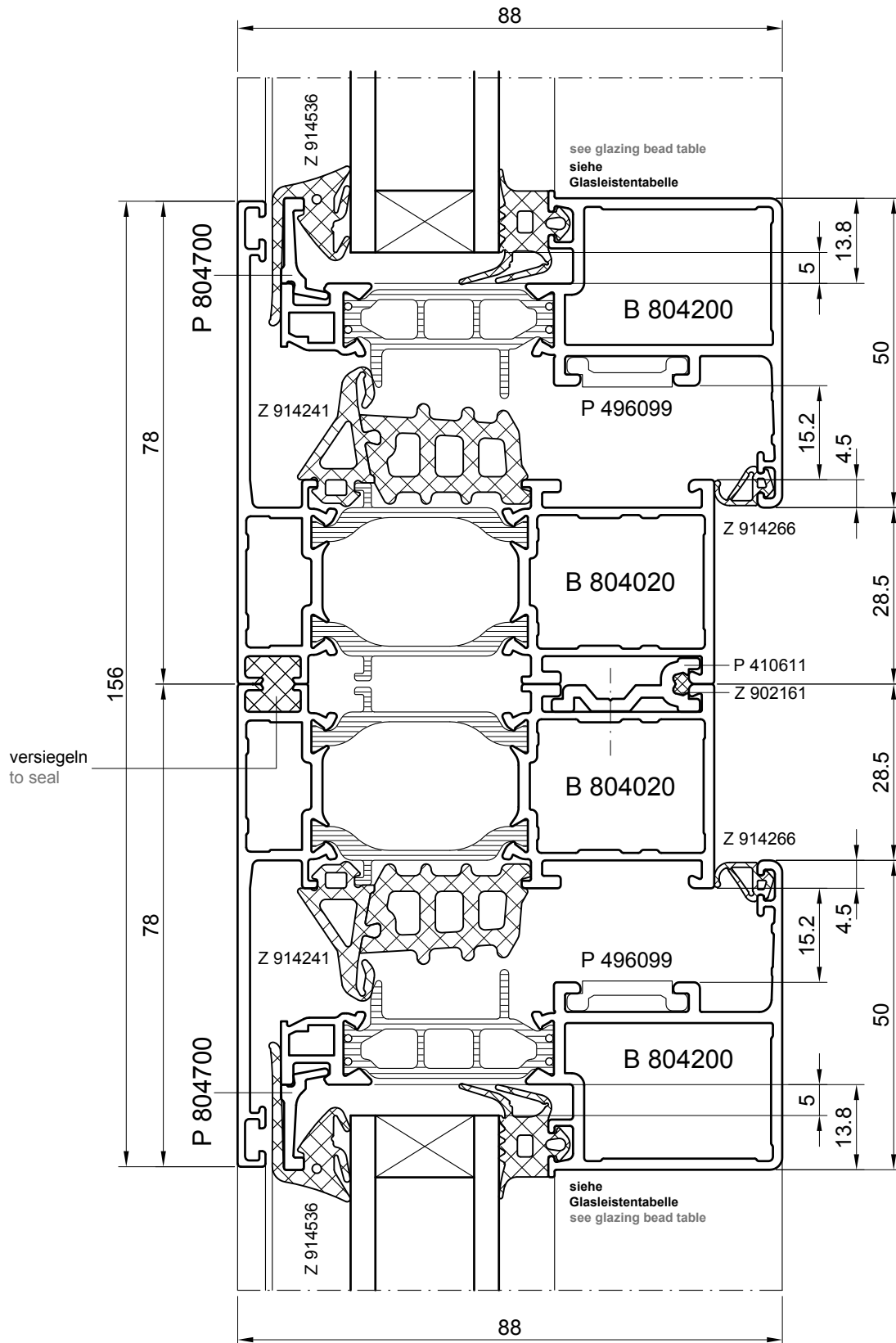
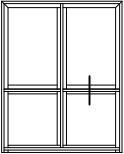

031000700

Dichtungen: siehe Register **Zubehör**
Gaskets: refer to register **Accessories**

M 1:1
Scale 1:1

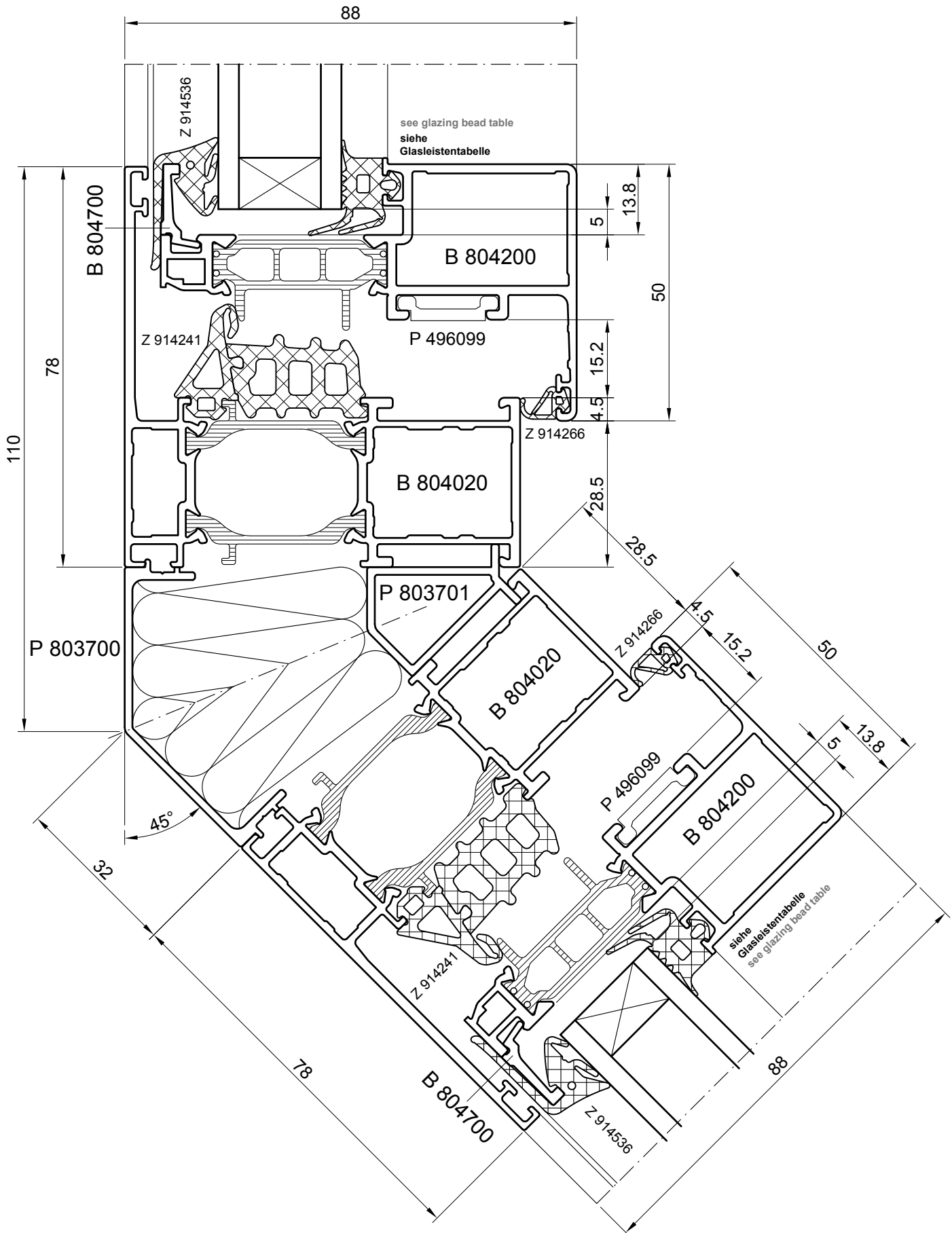

Dichtungen: siehe Register **Zubehör**
Gaskets: refer to register **Accessories**

M 1:1
Scale 1:1

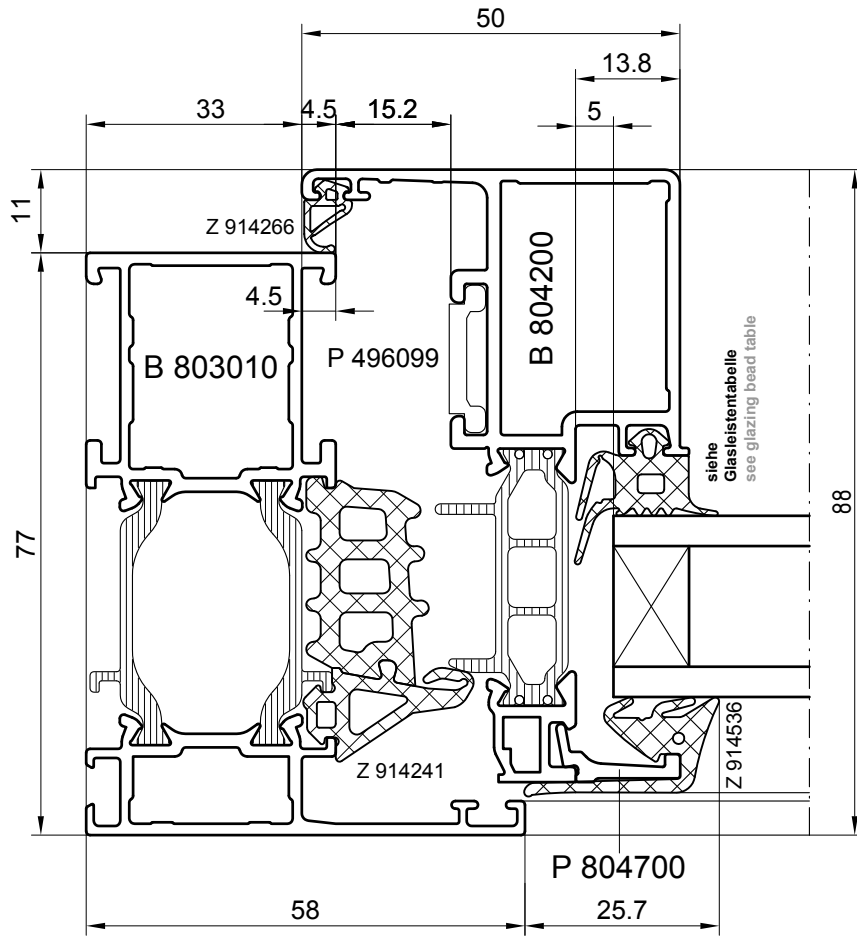
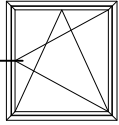

033000900

Dichtungen: siehe Register **Zubehör**
Gaskets: refer to register **Accessories**

M 1:1
Scale 1:1

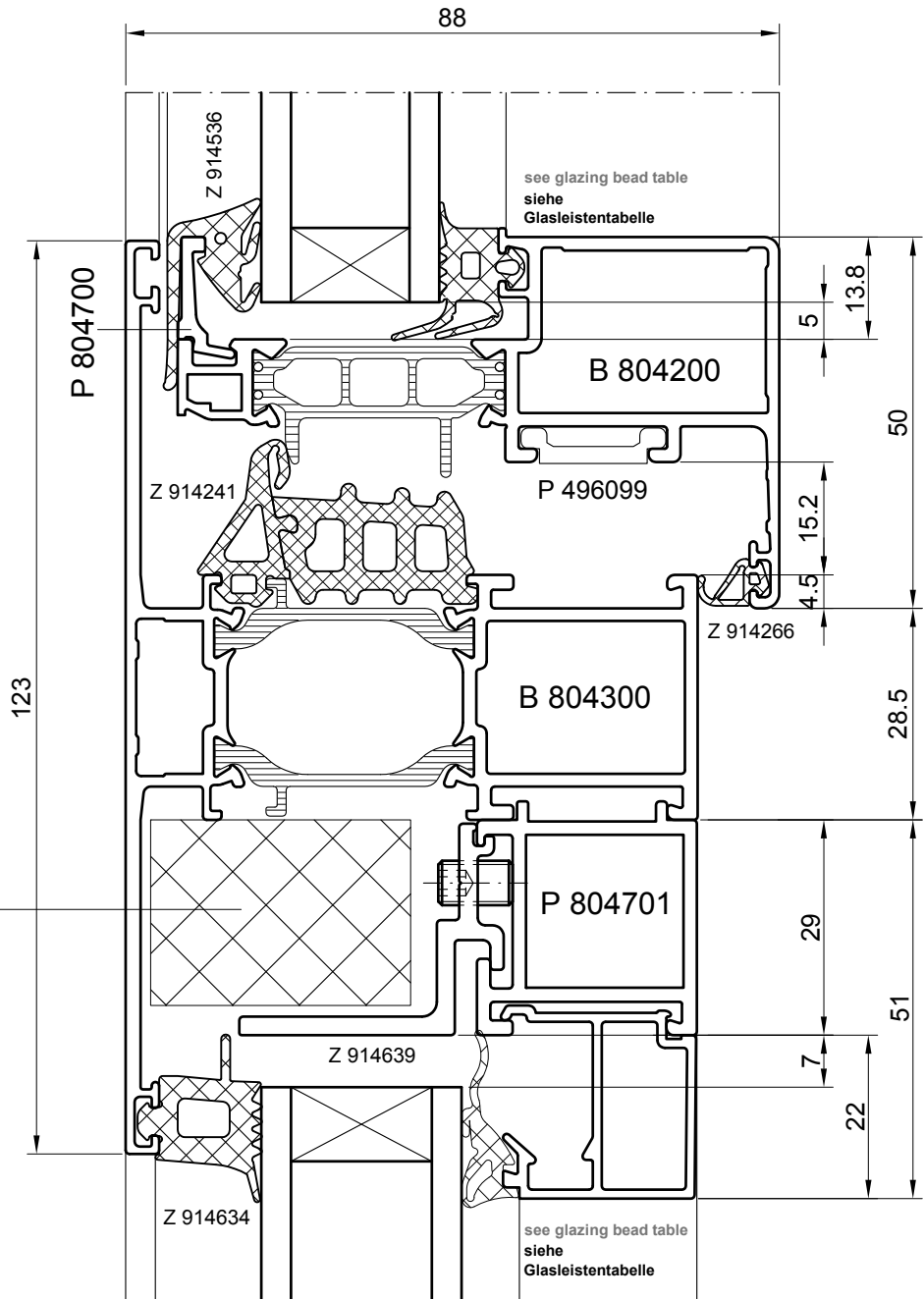
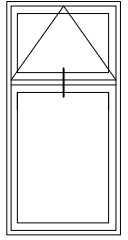

Dämmung 25 mm x 35 mm
Eigenfertigung
Siehe Verarbeitungshinweise

Insulation 25 mm x 35 mm
self production
Refer to register processing

034001101

Dichtungen: siehe Register **Zubehör**
Gaskets: refer to register **Accessories**

M 1:1
Scale 1:1