

Sicherheit Lambda

Safety Lambda

Lambda - Fensterserien Lambda - Window series

Inhaltsübersicht - Zubehör Contents - Accessories

**Seite
Page**

Inhaltsübersicht
Contents

2

Zubehör - Einbruchhemmung WK2 nach DIN ENV 1627
Accessories - burglar protection WK2 in accordance with DIN ENV 1627

3

Zubehör - Einbruchhemmung WK3 nach DIN ENV 1627
Accessories - burglar protection WK3 in accordance with DIN ENV
1627

4

Weiteres Zubehör - Einbruchhemmung WK2, WK3 nach DIN ENV 1627
Other accessories - burglar protection WK2, WK3 in accordance with DIN
ENV 1627

5 - 6

002000221

Achtung!

Darstellung ohne Schubstangen
Grundbeschläge für Dreh - Kippflügel: Register Beschläge Lambda
Schubstangenbearbeitung siehe 1054-02, 1055-02

Attention!

Representation without operating rods
Basic fittings for Turn-tilt sash fitting: register Fittings Lambda
Processing of operating rods see 1054-02, 1055-02

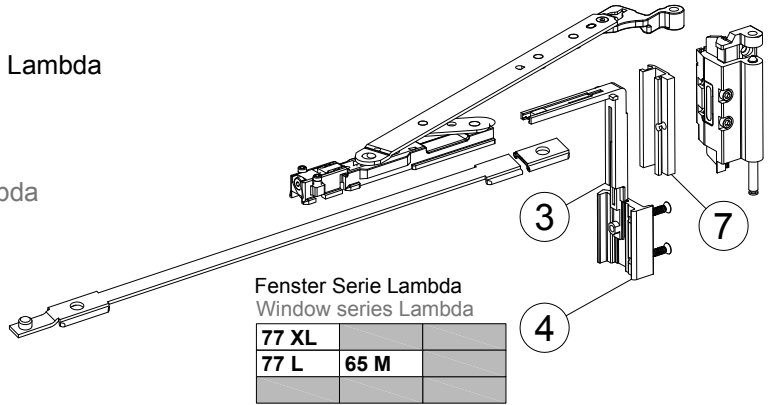

Fenster Serie Lambda
Window series Lambda

77 XL		
77 L	65 M	

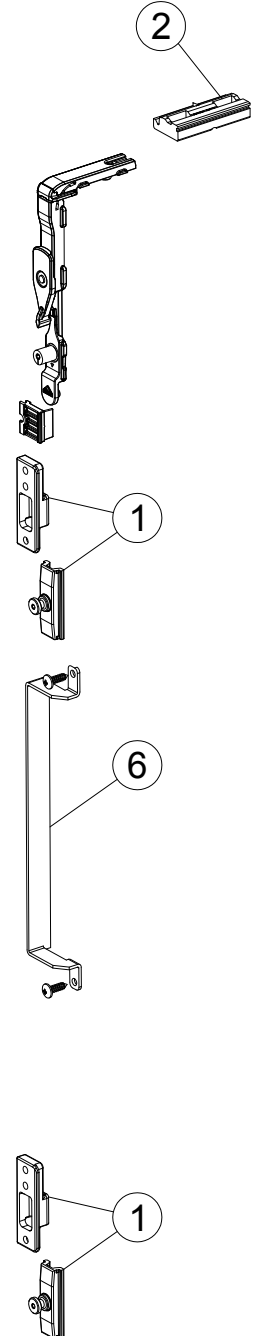

Z 996408

Beschlagzubehör
WK2 DIN L/R
Fittings accessories
WK2 DIN L/R

Z 996408

Pos. Pos.	Stck. Units	Bezeichnung Designation
①	4	Verriegelung WK2 * Locking WK2 *
②	1	Auflauf Blendrahmen Bearing fixed frame
③	1	Eckumlenkung Standard Corner linkage gear standard
④	1	Abdeckung Eckumlenkung Corner linkage gear cover
⑤	1	Aushebesicherung Lift-up security
⑥	1	Anbohrschutz für Falzgetriebe Drilling proof for rebate gear
⑦	-	Übersteckprofil ** Securing transmission corner piece **

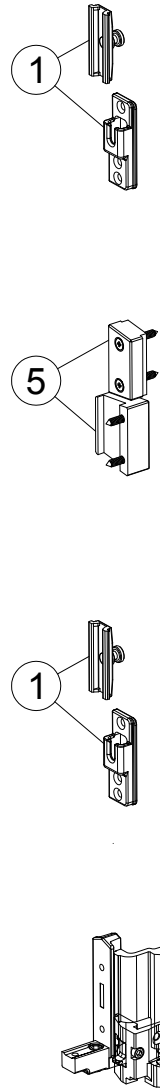

* Mindestmenge der Verriegelungen.
Bei größeren Flügeln erhöht sich die Anzahl der notwendigen Verriegelungen.
Siehe Zeichnung: 1053-02 / 1054-02 / 1055-02 / 1056-02

* Minimum number of locks.
For larger sashes the count of necessary locks increases.
See drawing: 1053-02 / 1054-02 / 1055-02 / 1056-02

** 1 Stück, bereits im Grundbeschlag enthalten.

** 1 piece, included in the basic fitting.

003002801

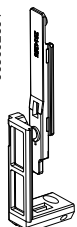

Achtung!

Darstellung ohne Schubstangen
Grundbeschläge für Dreh - Kippflügel: Register Beschläge Lambda
Schubstangenbearbeitung siehe 1056-02

Attention!

Representation without operating rods
Basic fittings for Turn-tilt sash fitting: register Fittings Lambda
Processing of operating rods see 1056-02

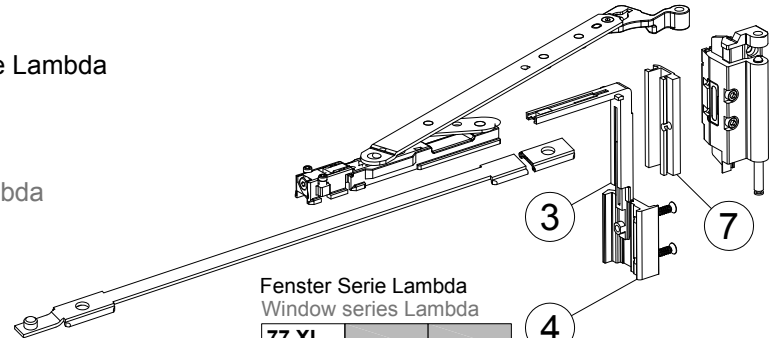
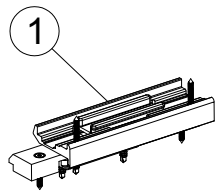
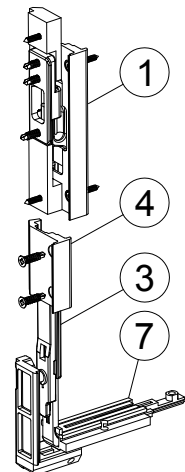
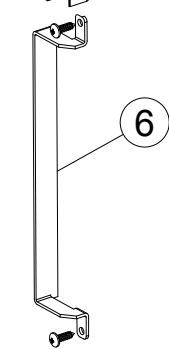
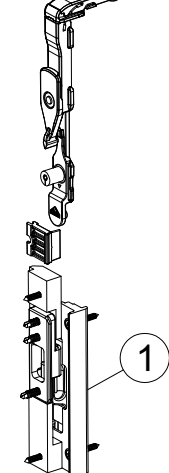
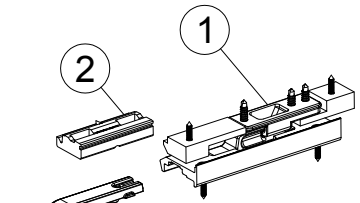

Fenster Serie Lambda
Window series Lambda

77 XL		
77 L	65 M	

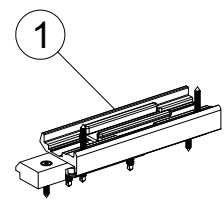
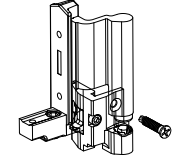
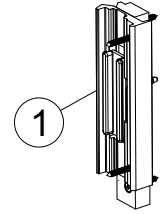
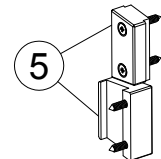
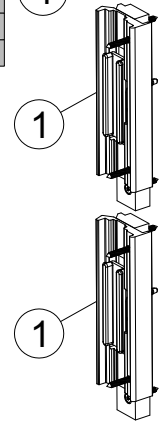

Z 996409

Beschlagzubehör
WK3 DIN L
Fittings accessories
WK3 DIN L

Z 996410

Beschlagzubehör
WK3 DIN R
Fittings accessories
WK3 DIN R

Z 996409 / Z 996410

Pos. Pos.	Stck. Units	Bezeichnung Designation
1	8	Verriegelung WK3 * Locking WK3 *
2	1	Auflauf Blendrahmen Bearing fixed frame
3	2	Eckumlenkung Standard Corner linkage gear standard
4	2	Abdeckung Eckumlenkung Corner linkage gear cover
5	1	Aushebesicherung Lift-up security
6	1	Anbohrschutz für Falzgetriebe Drilling proof for rebate gear
7	1	Übersteckprofil ** Securing transmission corner piece **

* Mindestmenge der Verriegelungen.
Bei größeren Flügeln erhöht sich die Anzahl der notwendigen Verriegelungen.
Siehe Zeichnung: 1053-02 / 1054-02 / 1055-02 / 1056-02

* Minimum number of locks.
For larger sashes the count of necessary locks increases.
See drawing: 1053-02 / 1054-02 / 1055-02 / 1056-02

** 1 Stück, bereits im Grundbeschlag enthalten.

** 1 piece, included in the basic fitting.

Bearbeitungs- und Montagezeichnung: Register 1000
Processing and assembly drawing: register 1000



Z 909948 02
Z 909948 64

Dreh-Kipp-Griff für Falzgetriebe
WK2 / WK3

Z 909948 02
Z 909948 64

Glass stop profile, fixed frame,
WK2 / WK3

Fenster Serie Lambda
Window series Lambda

77 XL		
77 L	65 M	



K 910098

Glasanschlagprofil, Festverglasung,
WK2 / WK3

K 910098

Glass stop profile, fixed frame,
WK2 / WK3

77 XL		
77 L		



K 910099

Glasanschlagprofil, Festverglasung,
WK2 / WK3

K 910099

Glass stop profile, fixed frame,
WK2 / WK3

	65 M	

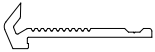

K 910100

Glasanschlagprofil, Flügel, WK2 / WK3

K 910100

Glass stop profile, sash WK2 / WK3

77 L		

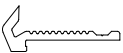

K 910101

Glasanschlagprofil, Flügel, WK2 / WK3

K 910101

Glass stop profile, sash WK2 / WK3

	65 M	

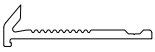

K 910102

Glasanschlagprofil, Flügel, WK2 / WK3

K 910102

Glass stop profile, sash WK2 / WK3

77 XL		

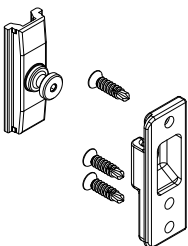

Z 996316

Verriegelung WK2 DIN L/R

Z 996316

Locking WK2 DIN L/R

77 XL		
77 L	65 M	

005002400

Bearbeitungs- und Montagezeichnung: Register 1000
Processing and assembly drawing: register 1000

Z 996372

Verriegelung WK3 DIN L

Z 996372

Locking WK3 DIN L

Z 996373

Verriegelung WK3 DIN R

Z 996373

Locking WK3 DIN R

Fenster Serie Lambda
Window series Lambda

77 XL		
77 L	65 M	

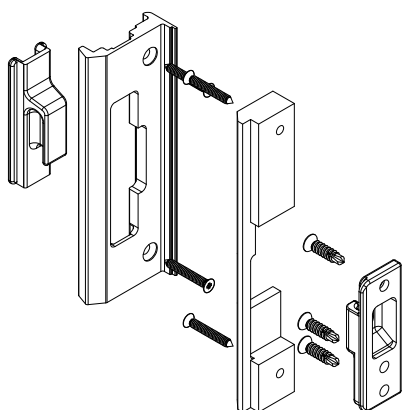
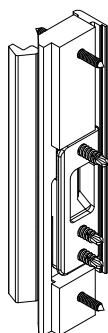

Z 996367

Anbohrschutz für Falzgetriebe
WK2 / WK3

Z 996367

drilling proof for rebate gear WK2 / WK3

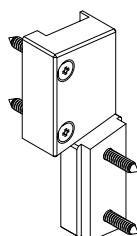

Z 996368

Aushebesicherung WK2 / WK3

Z 996368

lift-up security WK2 / WK3

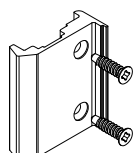

Z 996369

Abdeckung Eckumlenkung WK2 / WK3

Z 996369

capping corner linkage gear WK2 / WK3

006002500