

P 410670

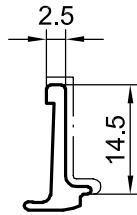

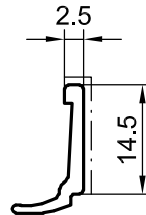

Series 1.0 IF

P 410672

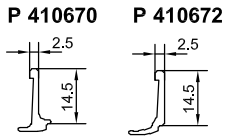

Series 1.0 IF

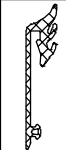

Glazing gaskets	external		internal					
			(F)	(A)	(B)	(C)	(D)	(E)
Article no.	Z 911 055	Z 911 839	Z 911 113	Z 911 074	Z 911 054	Z 911 075	Z 911 076	Z 911 077
Gap dimension in mm	5.5	4.5	2	4	6	8	10	12

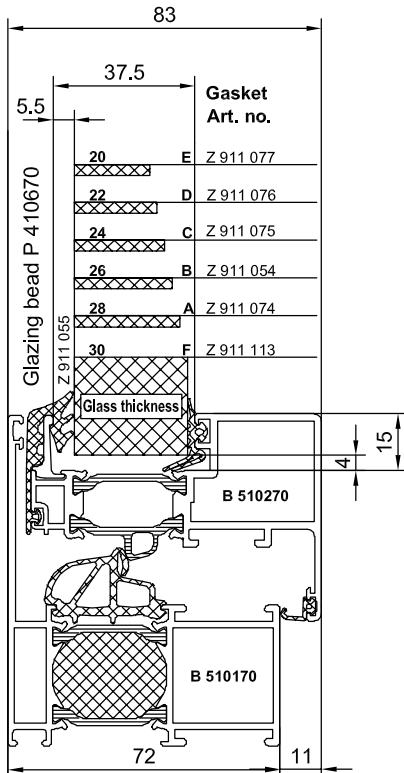

Notice!

Glazing beads **P 410670** and **P 410671** can only be used millfinished = **00** or, whenever corrosion prevention is required natural anodized = **02**. In case of special requirements on corrosion prevention a thickness of film of 25 µm has to be ordered separately.

Glazing bead table

For interlocking frame in the façade only

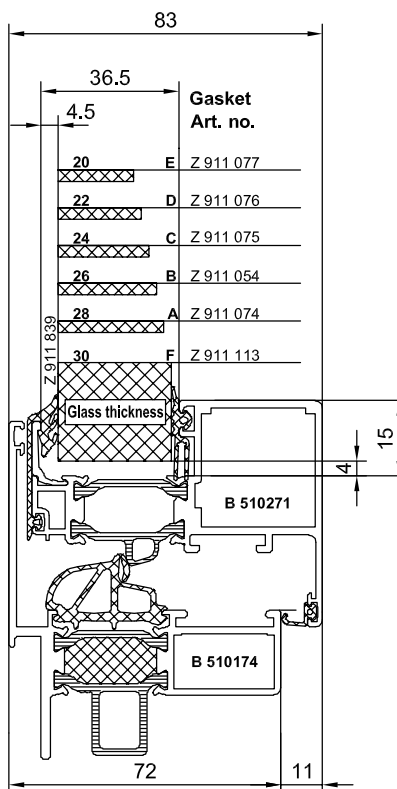
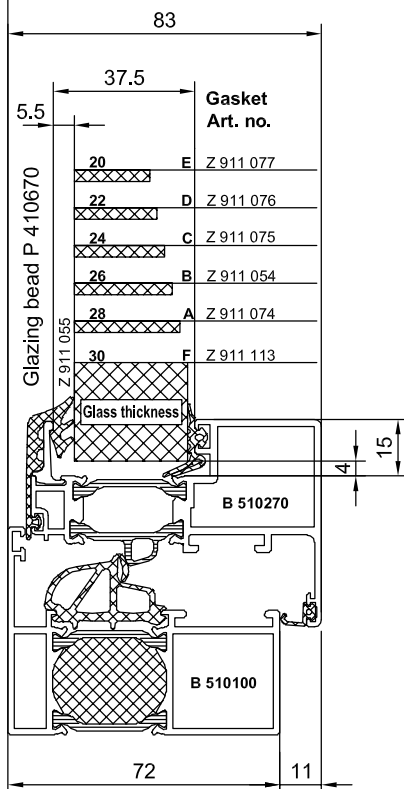

M 1:2

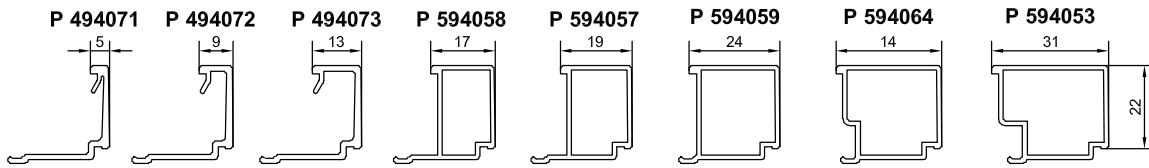

Glazing gaskets	external	internal			
	*	(A)	(B)	(C)	(D)
Article no.	Z 911 117	Z 911 072	Z 911 107	Z 911 019	Z 911 073
Gap dimension in mm	13	4,0 - 6,5	5,5 - 8,0	6,5 - 9,0	7,5 - 10,5

* Gasket frame made of Z 911 117 21

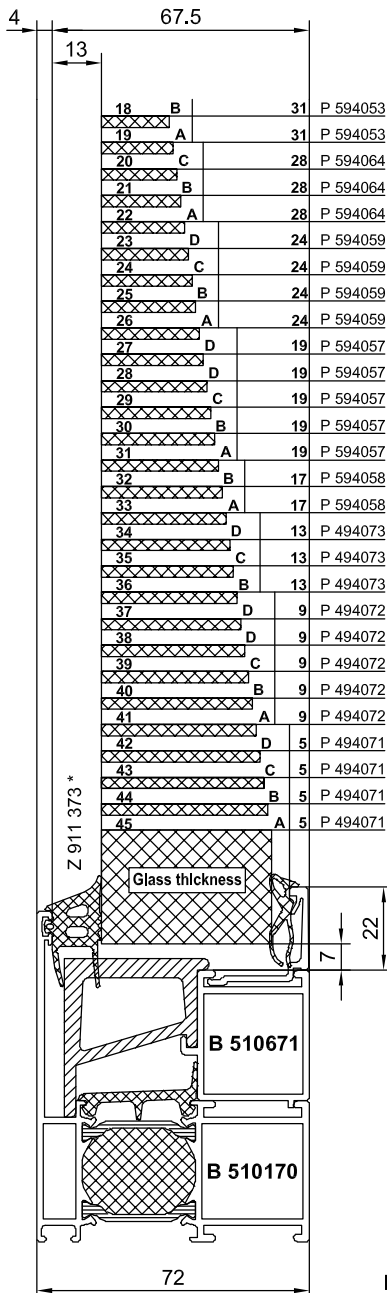

M 1:2