

M 1:1

crimpable available retro gluing after assembly	Outer chamber I					Inner chamber II						
B 542 100 / 102	Z 911 615	Z 911 029	Z 911 499	2 x Z 911 049	Z 911 187	-	Z 911 027	Z 911 030	Z 911 499	2 x Z 900 023	Z 903 233	
B 542 103 / 104	Z 911 615	Z 911 029	Z 911 499	2 x Z 911 049	Z 911 187	-	Z 911 027	Z 911 030	Z 911 499	2 x Z 900 023	Z 903 233	
B 542 100 / 102	-	Z 911 032	-	2 x Z 911 049	Z 911 187	-	Z 911 031	-	Z 911 500	2 x Z 911 049	Z 911 187	
B 542 103 / 104	-	Z 911 032	-	2 x Z 911 049	Z 911 187	-	Z 911 031	-	Z 911 500	2 x Z 911 049	Z 911 187	

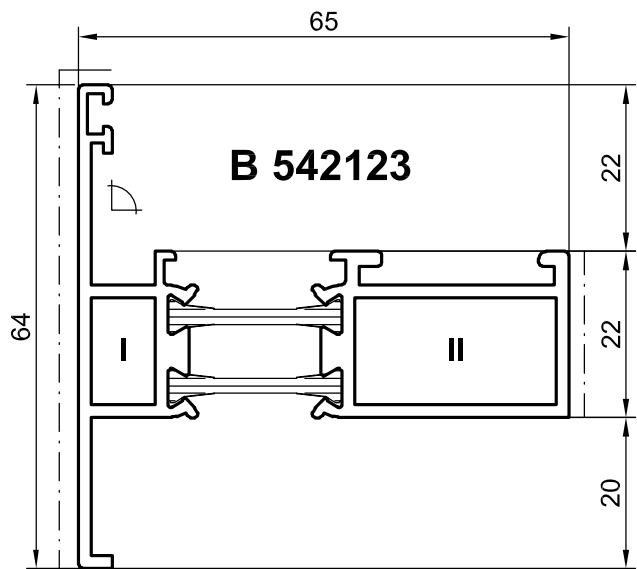

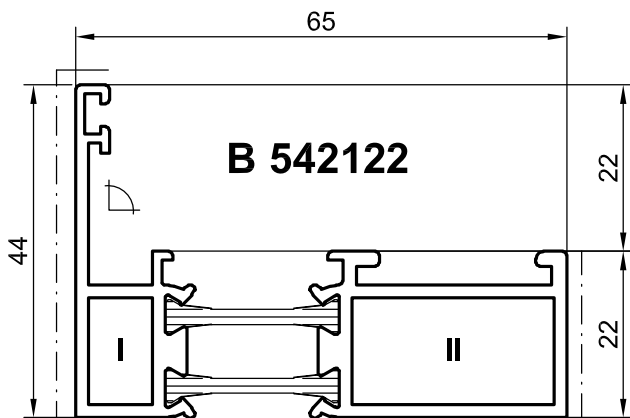

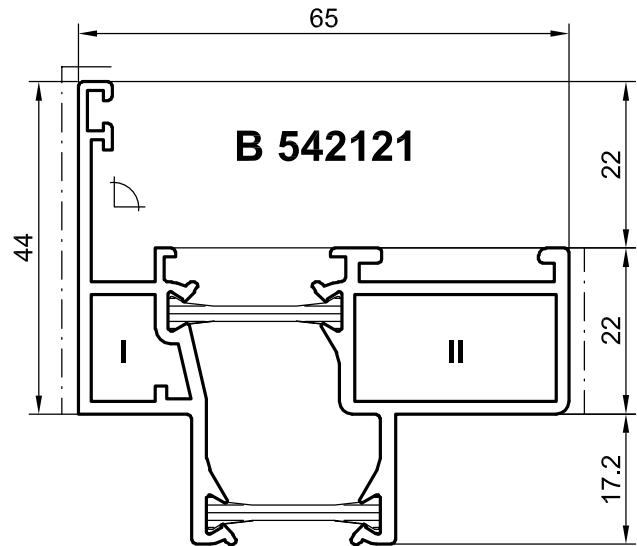
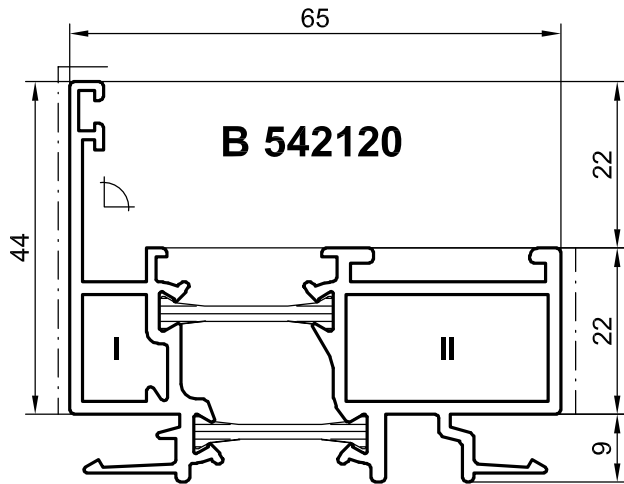
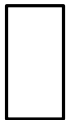

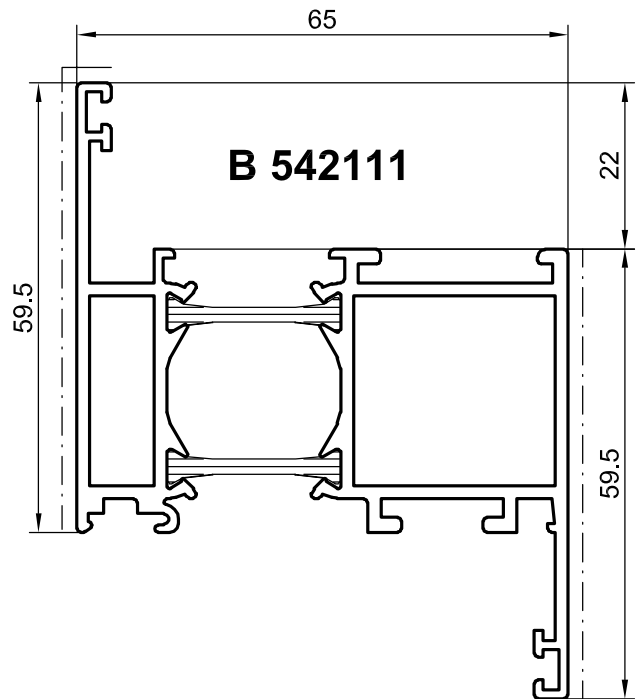
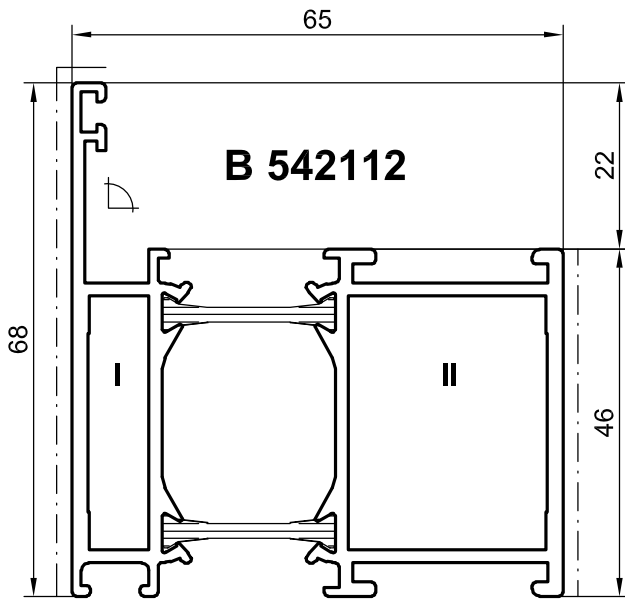
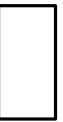









M 1:1

crimpable available retro gluing after assembly	Outer chamber I					Inner chamber II					
B 542 120 / 121	Z 911 615	Z 911 487	Z 911 499	2 x Z 911 049	Z 911 187	-	Z 911 486	Z 911 488	Z 911 499	2 x Z 900 023	Z 903 233
B 542 122 / 123	Z 911 615	Z 911 487	Z 911 499	2 x Z 911 049	Z 911 187	-	Z 911 486	Z 911 488	Z 911 499	2 x Z 900 023	Z 903 233
B 542 120	-	Z 911 493	-	2 x Z 911 513	Z 911 187	-	Z 911 492	-	Z 911 500	2 x Z 911 513	Z 911 187
B 542 122 / 123	-	Z 911 493	-	2 x Z 911 513	Z 911 187	-	Z 911 492	-	Z 911 500	2 x Z 911 513	Z 911 187



M 1:1

 crimpable  available  retro gluing after assembly	Outer chamber I					Inner chamber II						
												
B 542 111	Z 911 615	Z 911 029	Z 911 499	2 x Z 911 049	Z 911 187	-	Z 911 027	Z 911 030	Z 911 499	2 x Z 900 023	Z 903 233	
B 542 112	Z 911 615	Z 911 677	Z 911 499	2 x Z 911 049	Z 911 187	-	Z 911 120	Z 911 121	Z 911 499	2 x Z 900 023	Z 903 233	
B 542 111	-	Z 911 032	-	2 x Z 911 049	Z 911 187	-	Z 911 031	-	Z 911 500	2 x Z 911 049	Z 911 187	
B 542 112	-	Z 911 126	-	2 x Z 911 049	Z 911 187	-	Z 911 125	-	Z 911 500	2 x Z 911 049	Z 911 187	

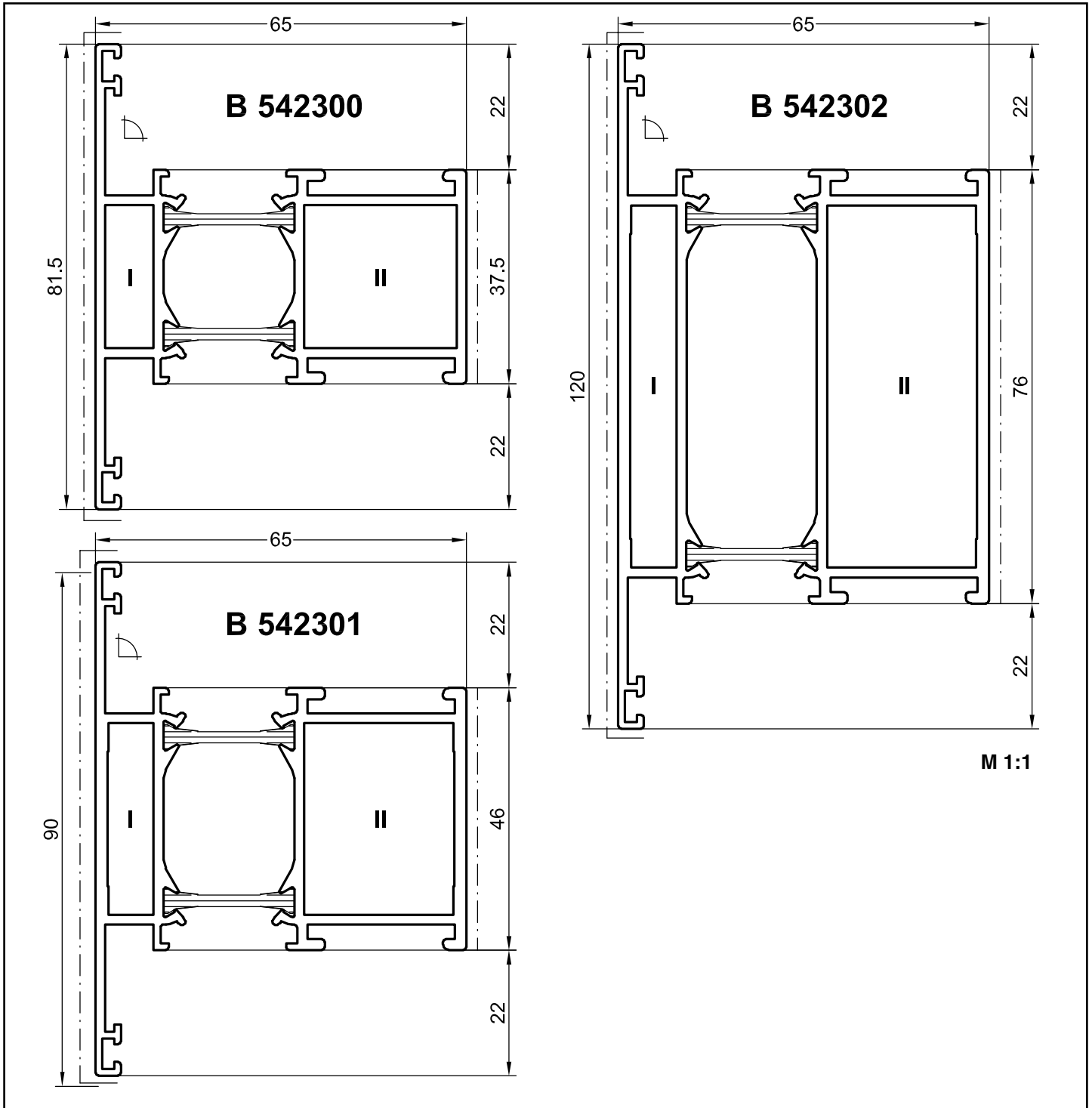
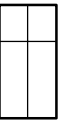

M 1:1

crimpable nailable retro gluing after assembly	Outer chamber I					Inner chamber II					
B 542 300	Z 911 615	Z 911 029	Z 911 499	2 x Z 911 049	Z 911 187	-	Z 911 027	Z 911 030	Z 911 499	2 x Z 900 023	Z 903 233
B 542 301	Z 911 615	Z 911 677	Z 911 499	2 x Z 911 049	Z 911 187	-	Z 911 120	Z 911 121	Z 911 499	2 x Z 900 023	Z 903 233
B 542 302	Z 911 615	Z 911 726	Z 911 499 Z 911 501	4 x Z 911 049	Z 911 187	-	Z 994 167	-	Z 911 499 Z 911 501	4 x Z 900 023	Z 903 233
B 542 300	-	Z 911 032	-	2 x Z 911 049	Z 911 187	-	Z 911 031	-	Z 911 500	2 x Z 911 049	Z 911 187
B 542 301	-	Z 911 126	-	2 x Z 911 049	Z 911 187	-	Z 911 125	-	Z 911 500	2 x Z 911 049	Z 911 187
B 542 302	-	Z 911 039	-	2 x Z 911 049	Z 911 187	-	Z 911 038	-	Z 911 500	2 x Z 911 049	Z 911 187

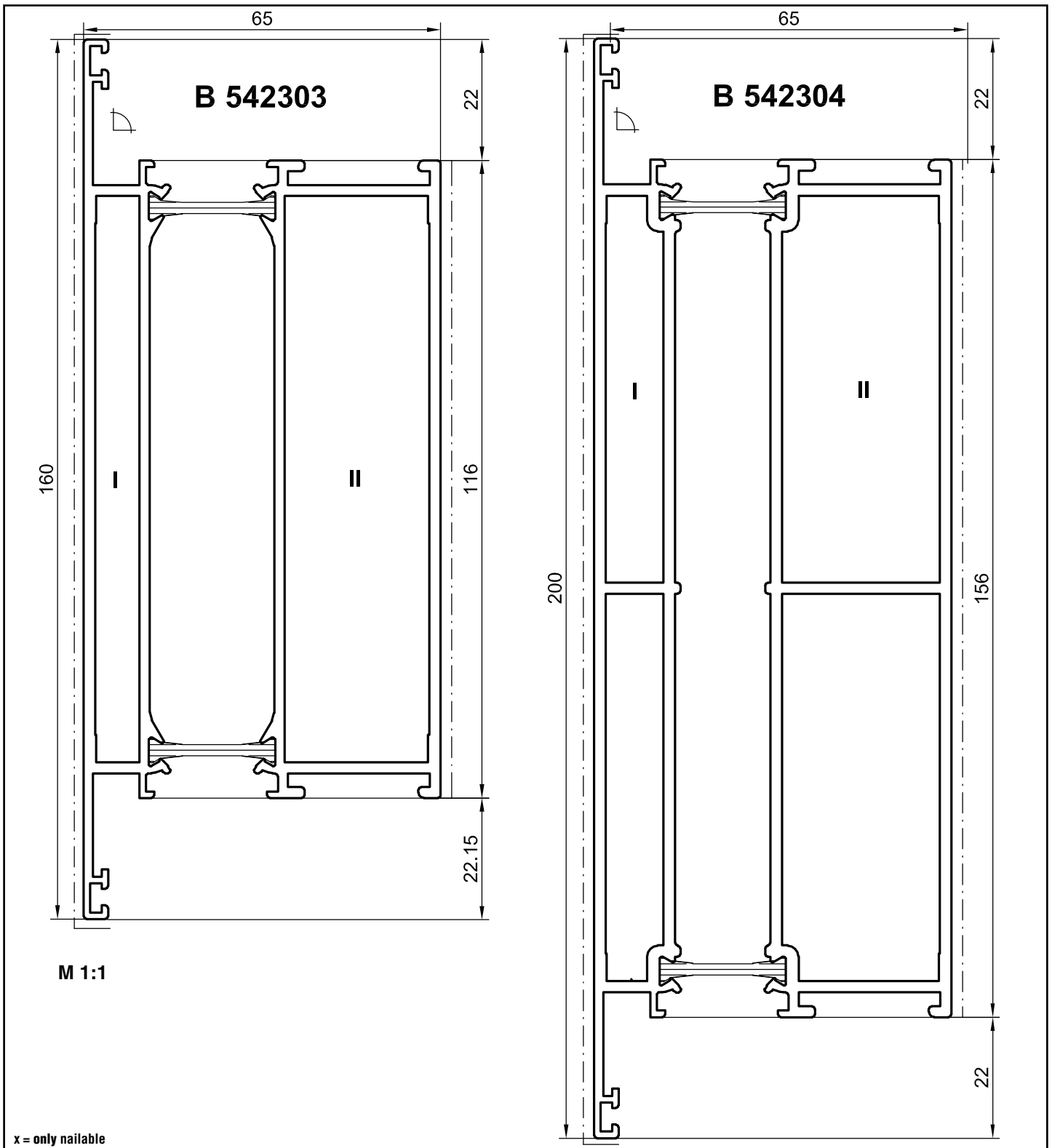
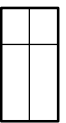

M 1:1

x = only nailable

crimpable nailable retro gluing after assembly	Outer chamber I					Inner chamber II					
B 542 303	Z 911 615	Z 911 203 x	Z 911 499 Z 911 501	4 x Z 911 049	Z 911 187	-	Z 994 052 x	-	Z 911 499 Z 911 501	4 x Z 900 023	Z 903 233
B 542 303	-	Z 911 041	-	2 x Z 911 049	Z 911 187	-	Z 911 040	-	Z 911 500	2 x Z 911 049	Z 911 187
B 542 304	-	Z 911 043	-	2 x Z 911 049	Z 911 187	-	Z 911 042	-	Z 911 500	2 x Z 911 049	Z 911 187