

| crimpable nailable retro gluing after assembly | Chamber I | | | | | |
|--|-----------|-----------|-----------|-----------|---------------|-----------|
| | | | | | | |
| P 572 100 / 103 / 104 / 105 | Z 907 315 | Z 912 324 | Z 912 325 | Z 908 551 | 2 x Z 900 023 | Z 903 233 |
| P 572 101 | Z 907 315 | Z 912 326 | Z 912 327 | Z 908 551 | 2 x Z 900 023 | Z 903 233 |
| P 572 102 | Z 907 315 | Z 912 328 | Z 912 329 | Z 908 551 | 2 x Z 900 023 | Z 903 233 |
| | | | | | | |
| P 572 100 / 103 / 104 / 105 | - | Z 908 931 | - | Z 909 084 | 2 x Z 907 432 | Z 911 187 |
| P 572 101 | - | Z 908 936 | - | Z 909 084 | 2 x Z 907 422 | Z 911 187 |
| P 572 102 | - | Z 908 933 | - | Z 909 084 | 2 x Z 907 422 | Z 911 187 |

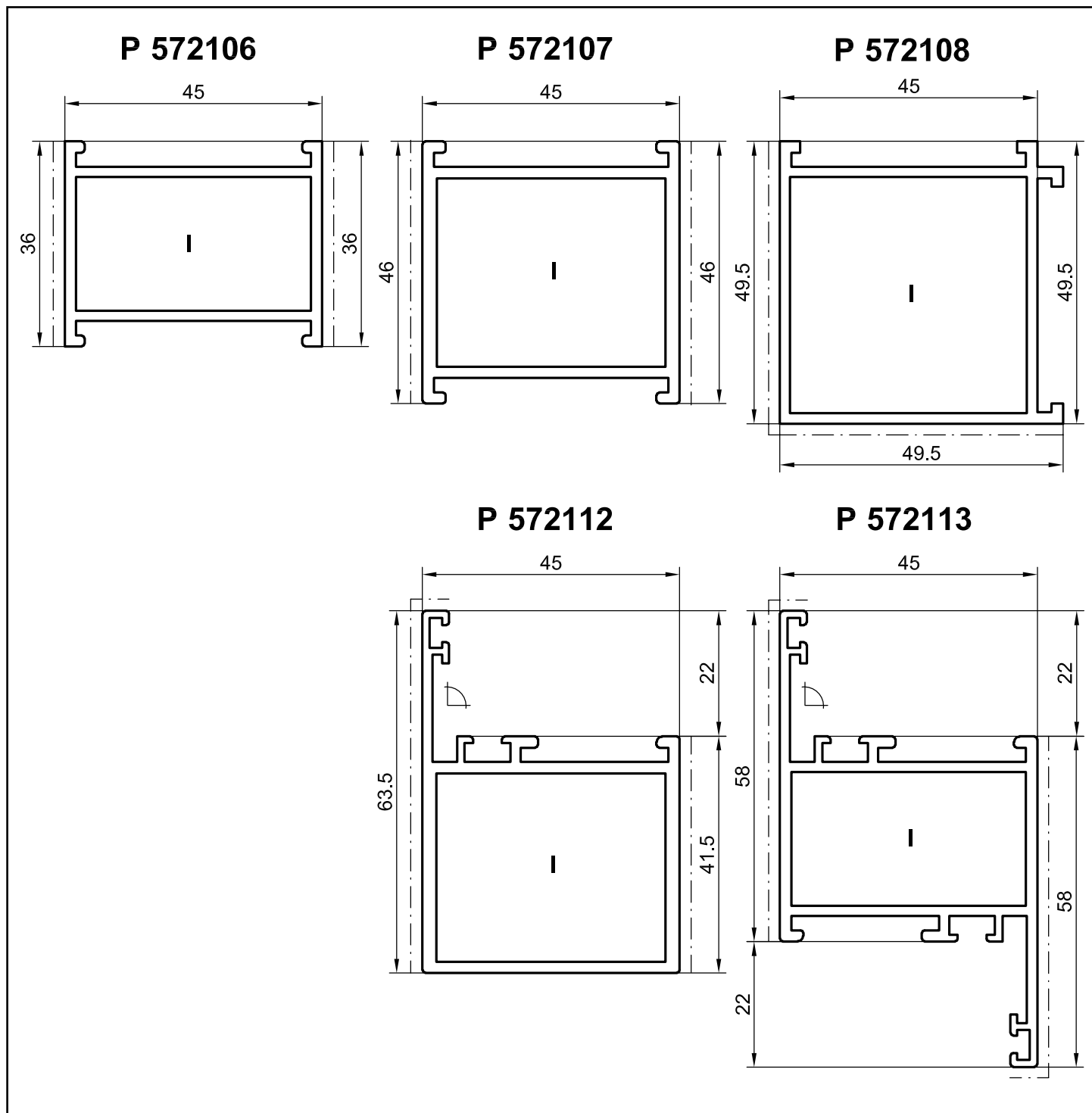

| crimpable nailable retro gluing after assembly | Chamber I | | | | | |
|--|---------------|-----------|-----------|-----------|---------------|-----------|
| | | | | | | |
| P 572 106 | Z 907 315 | Z 912 326 | Z 912 327 | Z 908 551 | 2 x Z 900 023 | Z 903 233 |
| P 572 107 / P 572 112 | - / Z 907 315 | Z 912 328 | Z 912 329 | Z 908 551 | 2 x Z 900 023 | Z 903 233 |
| P 572 113 | Z 907 315 | Z 912 326 | Z 912 327 | Z 908 551 | 2 x Z 900 023 | Z 903 233 |
| | | | | | | |
| P 572 106 / P 572 113 | - | Z 908 936 | - | Z 909 084 | 2 x Z 907 422 | Z 911 187 |
| P 572 107 | - | Z 908 940 | - | Z 909 084 | 2 x Z 907 422 | Z 911 187 |
| P 572 112 | - | Z 908 933 | - | Z 909 084 | 2 x Z 907 422 | Z 911 187 |

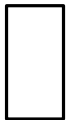

P 572306

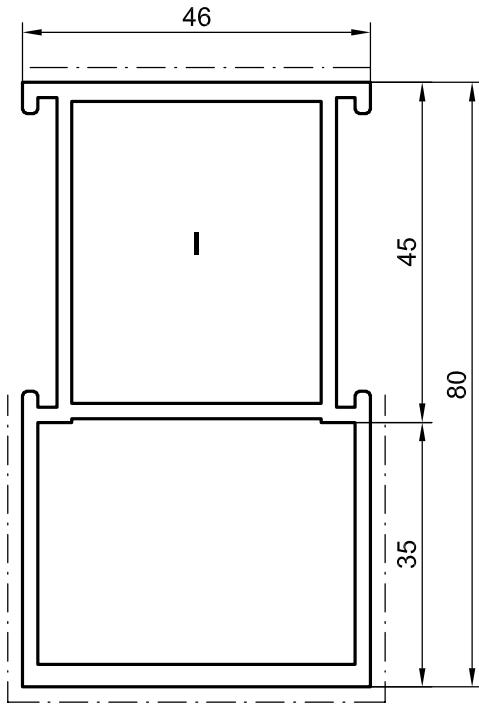

P 572307

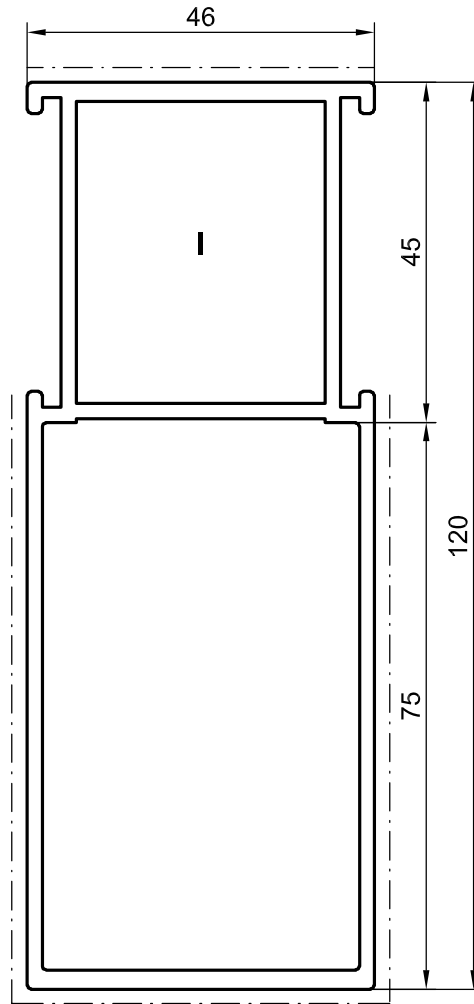

P 572111

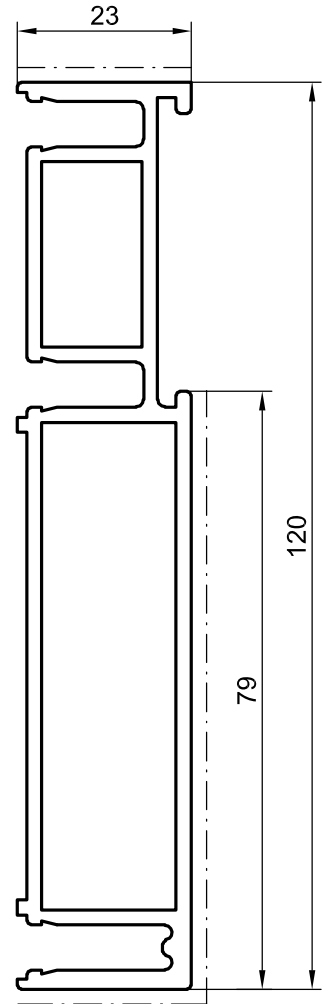



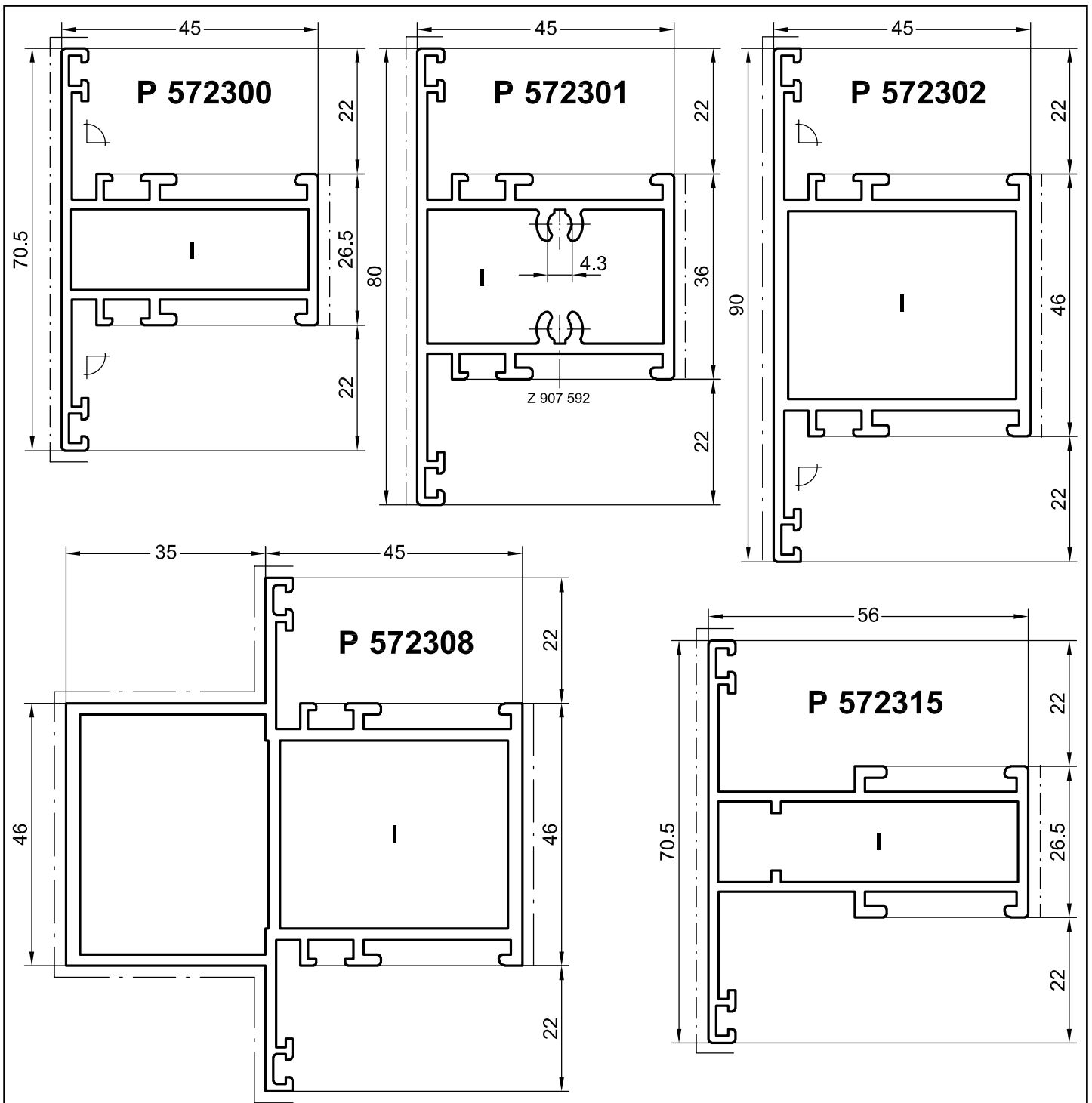

| crimpable nailable retro gluing after assembly | Chamber I | | | | | |
|--|-----------|-----------|-----------|-----------|---------------|---------------|
| | P 572 306 | Z 907 315 | Z 912 328 | Z 912 329 | Z 908 551 | 2 x Z 900 023 |
| P 572 306 / P 572 307 | - | Z 908 940 | - | Z 909 084 | 2 x Z 907 422 | Z 911 187 |

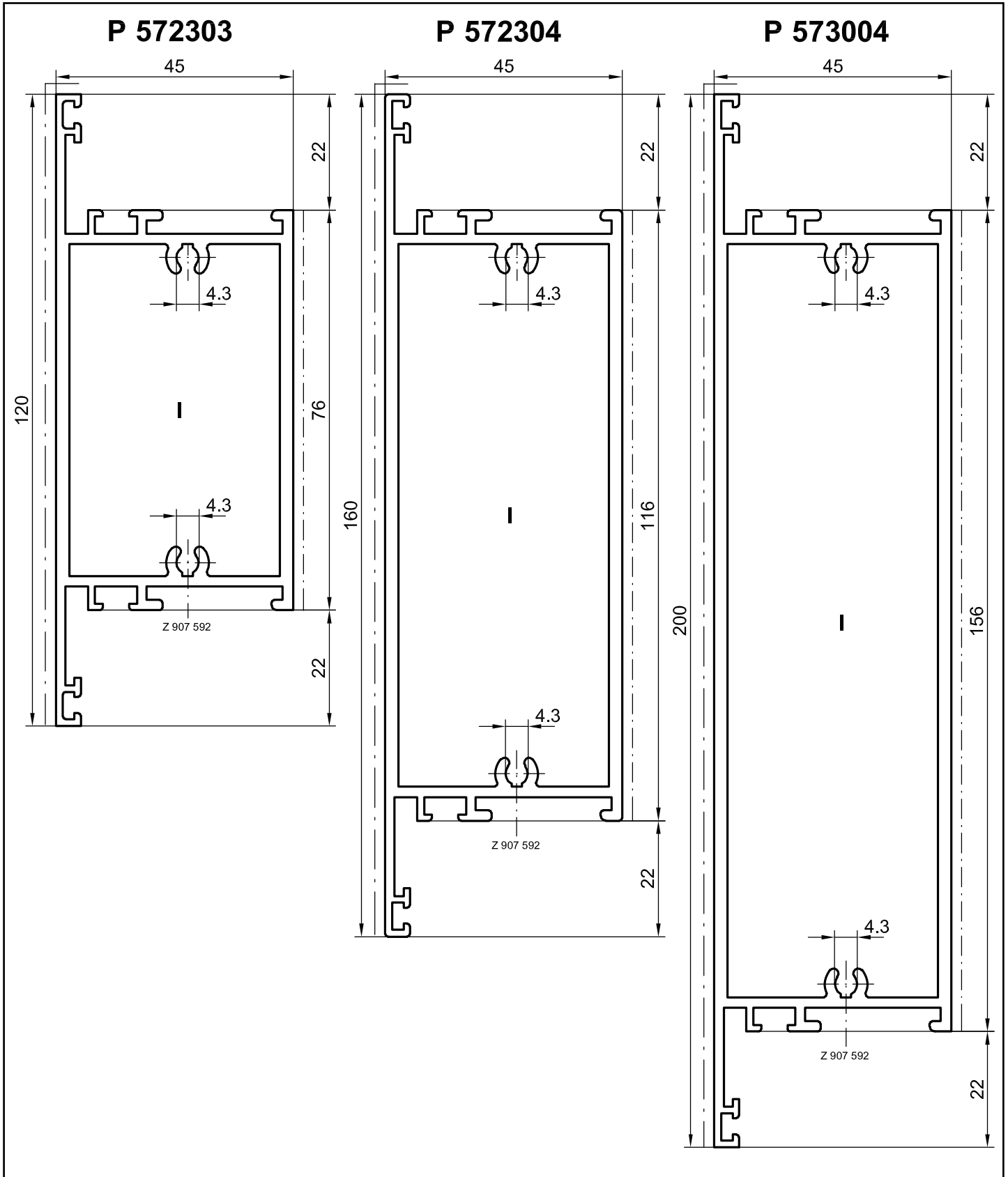
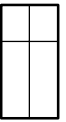

| <input type="checkbox"/> crimpable <input type="checkbox"/> nailable <input type="checkbox"/> retro gluing after assembly | Chamber I | | | | | |
|---|-----------|-----------|---------------|-----------|---------------|-----------|
| | | | | | | |
| P 572 300 | Z 907 315 | Z 912 324 | Z 912 325 | Z 908 551 | 2 x Z 900 023 | Z 903 233 |
| P 572 302 | Z 907 315 | Z 912 328 | Z 912 329 | Z 908 551 | 2 x Z 900 023 | Z 903 233 |
| P 572 300 | - | Z 908 931 | - | Z 909 084 | 2 x Z 907 432 | Z 911 187 |
| P 572 301 | - | Z 908 932 | - | Z 909 084 | 2 x Z 907 684 | Z 911 187 |
| P 572 302 / 308 | - | Z 908 933 | - | Z 909 084 | 2 x Z 907 422 | Z 911 187 |
| P 572 315 | - | Z 908 950 | 2 x Z 900 859 | Z 909 084 | 2 x Z 907 432 | Z 911 187 |

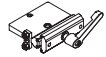

| Chamber I | | | | | | |
|-----------|---|---|---|---|---|---|
| |  |  |  |  |  |  |
| P 572 303 | - | Z 908 934 | - | Z 909 084 | 2 x Z 907 684 | Z 911 187 |
| P 572 304 | - | Z 908 935 | - | Z 909 084 | 2 x Z 907 684 | Z 911 187 |
| P 573 004 | - | Z 908 946 | - | Z 909 084 | 2 x Z 907 684 | Z 911 187 |

P 573005

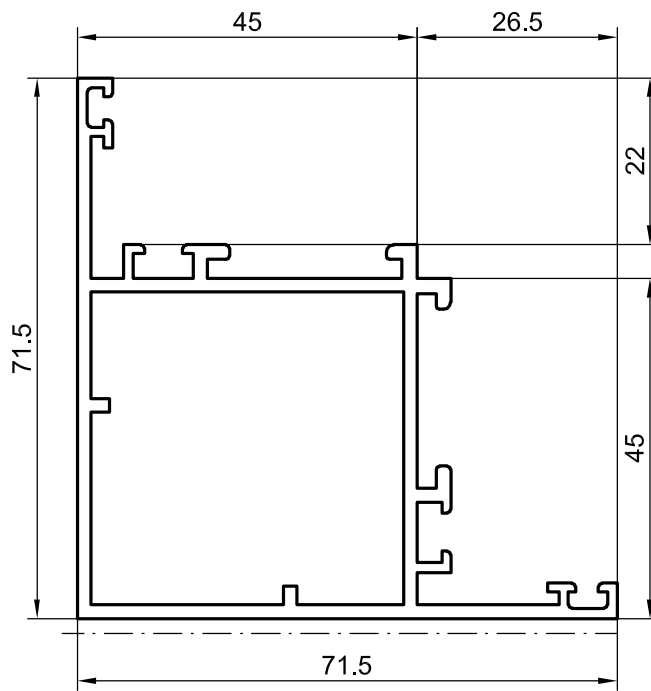

P 573007

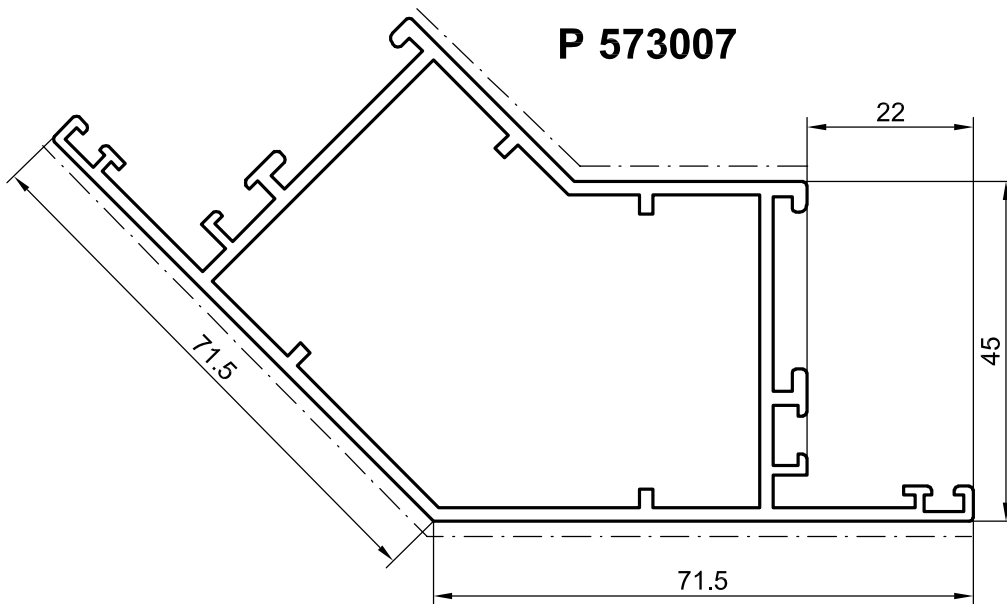

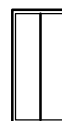

P 572210

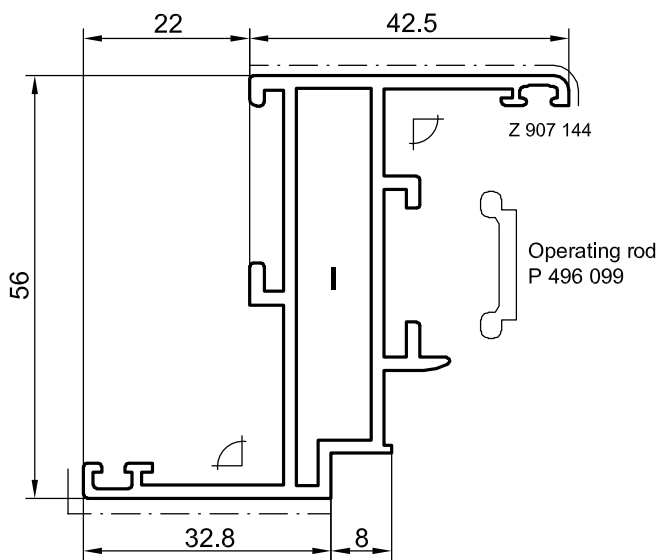

P 572211

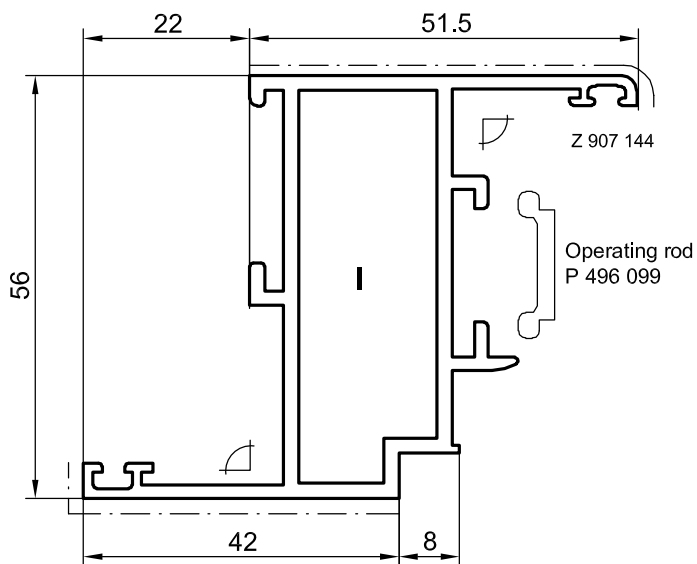

P 572212

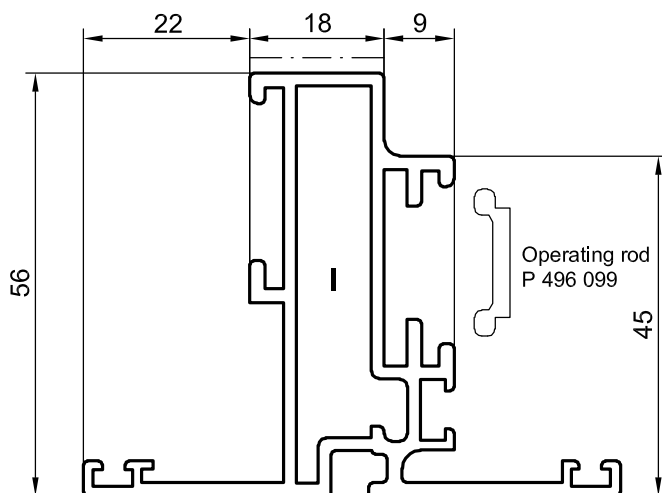

P 572213

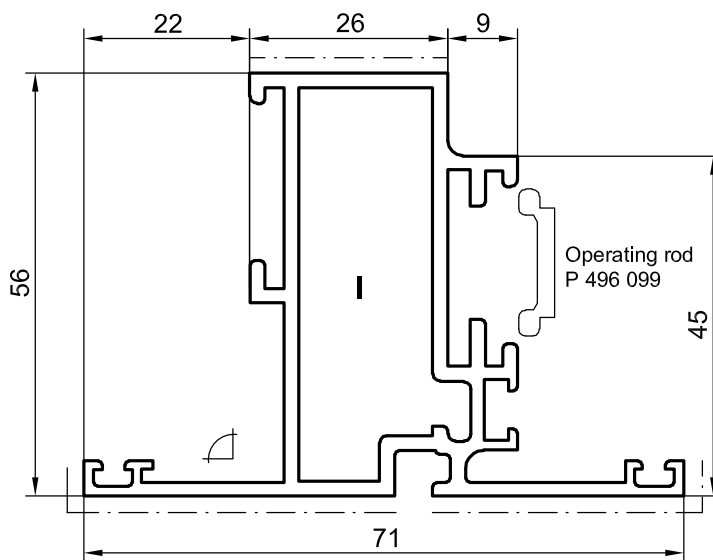

| crimpable nailable retro gluing after assembly | Chamber I | | | | | |
|--|------------------------|-----------|-----------|-----------|---------------|-----------|
| | | | | | | |
| P 572 210 / P 572 212 | Z 911 615 Z 911 616 | Z 912 332 | Z 912 333 | Z 908 551 | 2 x Z 906 971 | Z 903 233 |
| P 572 211 / P 572 213 | Z 911 615 Z 911 616 | Z 912 334 | Z 912 335 | Z 908 551 | 2 x Z 900 023 | Z 903 233 |



P 572601

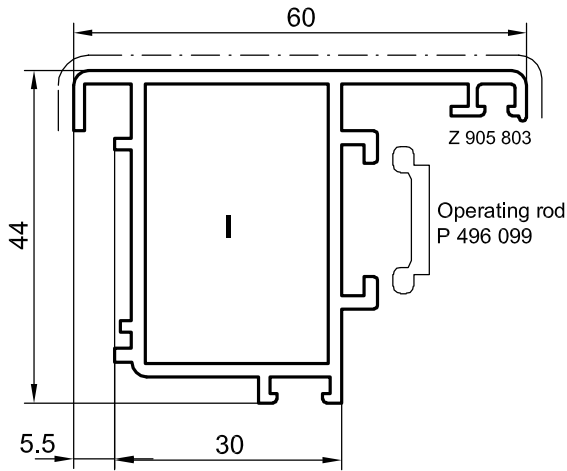

P 572204

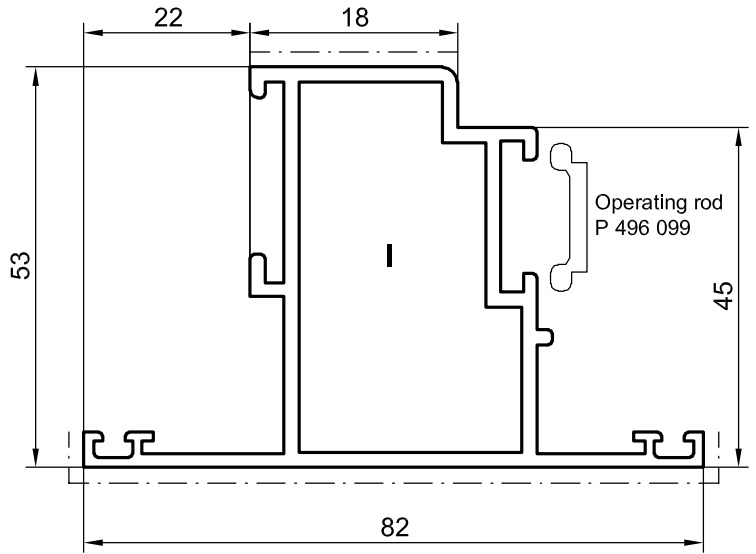

P 572205

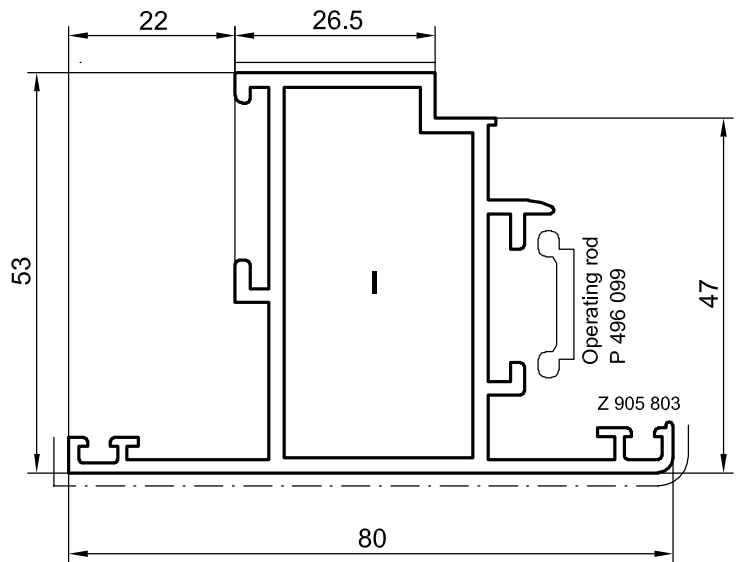

| crimpable nailable retro gluing after assembly | Chamber I | | | | | |
|--|------------------------|-----------|---|-----------|---------------|-----------|
| | | | | | | |
| P 572 204 | Z 911 615 Z 911 616 | Z 908 555 | Z 908 631 | Z 908 551 | 2 x Z 900 024 | Z 903 233 |
| P 572 205 | Z 911 615 Z 907 316 | Z 912 330 | Z 912 331 • = only retro gluing after assembly | Z 908 551 | 2 x Z 900 024 | Z 903 233 |
| P 572 601 | Z 907 316 | Z 908 556 | Z 908 633 | Z 908 746 | 2 x Z 900 023 | Z 903 233 |