

Rebate gear for side-hung / turn-tilt sash,
suitable for sash profiles
B 510 200 / 201 / 202 / 270 / 271 + P 572 200 / 201
Processing drawing: Register 100

Rebate gear for side-hung / turn-tilt fittings,
suitable for sash profile B 510 202
Processing drawing: Register 100

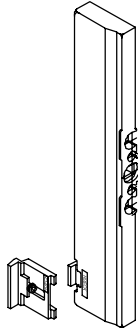

Z 993 450
Rebate gear,
including safety device to
prevent false operation,
suitable for turn/tilt sashes,
designed for handles with
7 mm square pin and rosette
with 43 mm hole pitch



Z 909 290
Rebate gear,
as above but without safety
device to prevent
false operation,
suitable for side-hung sashes

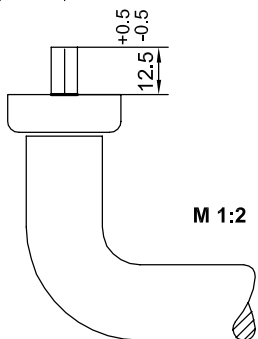
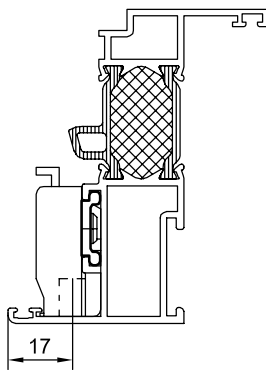

Attention!
If other equipment is used,
make sure it is fitted with a catch.
Shorten square pin correspondingly.

Series		
1.0	1.0 IF	A 72
•	•	•
•	•	•

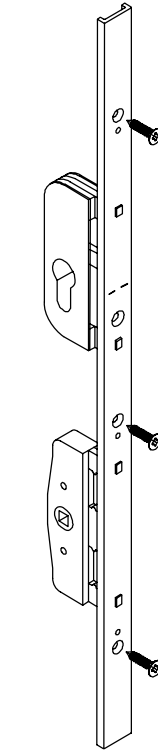

Z 993 130 02
Z 993 130 64
Gear with 7 mm pin,
for inside and outside
operation, lockable,
designed for profile cylinder

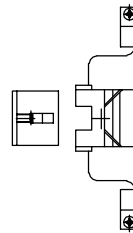

Z 992 936
Safety device to deter
incorrect operation,
required for turn-tilt
sashes, must be installed
separately

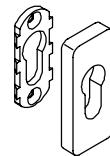

Z 994 067 02
Z 994 067 64
Safety rosette, 9 mm high,
two-part, for outside use,
to be used in combination
with a profile cylinder with
gear **Z 993 130**

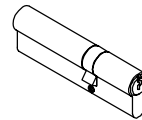

Z 911 342
Profile cylinder,
extended on both sides,
35 / 70 mm, matt nickel,
with 3 keys,
suitable for gear **Z 993 130**

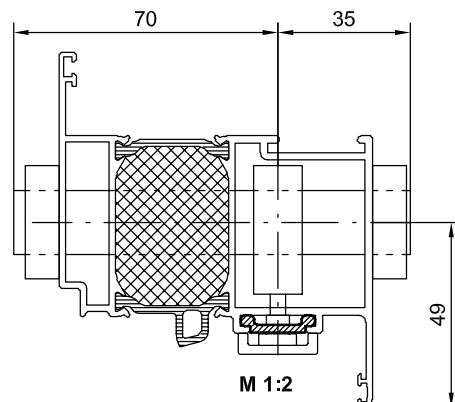

Series
1.0
•
•
•