











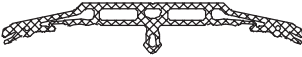

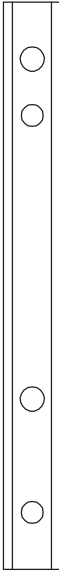
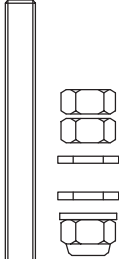
## Overview of sealing systems for polygonal construction and roof

External roof sealing system	Internal sealing system sealing system	External polygonal sealing system, 6° to 45°	Internal polygonal sealing system, 6° to 45°
<p><b>912 823</b> External glazing gasket, black, suitable for pressure plate profile 419431 In roof area</p> 	<p><b>912 822</b> Internal drainage gasket inside the roof transom, black</p> 	<p><b>911 831 - 911 835</b> External glazing gasket,</p> 	<p><b>912 802</b> Internal polygonal glazing gasket, black, gap dimension 4</p> 
<p><b>912 638</b> Butyl Tape covered with aluminium plastic foil, 35 x 1.5 mm</p>	<p><b>912 824</b> Internal glazing gasket, black, gap dimension 14</p> 	<p><b>Sun shade fixing</b> <b>912786 Support profile</b> excluding fixing screws</p>  <p><b>Stud</b></p> <p><b>994 688 M8x100</b> <b>994 689 M8x120</b> <b>994 690 M8x140</b> <b>994 691 M8x180</b></p> 	<p><b>912 803</b> Internal polygonal glazing gasket, black, gap dimension 6</p> 
<p><b>912 851</b> Butyl Tape covered with aluminium plastic foil, 80 x 1.5 mm</p>	<p><b>912 825</b> Internal glazing gasket, black, gap dimension 16</p> 		<p><b>912 804</b> Internal polygonal glazing gasket, black, gap dimension 8</p> 
<p><b>912 853</b> Butyl Tape covered with aluminium plastic foil, 100 x 1.5 mm</p>	<p><b>912 819</b> Sealing piece, 500 x 46 x 5 mm EPDM cellular rubber with stainless steel plate A2</p> 		<p><b>912 805</b> Internal polygonal glazing gasket, black, gap dimension 10</p> 
<p><b>912 861</b> Glass weight discharge for roof area, for a rebate width of 32 mm, length = 100 mm</p> 	<p><b>912 865</b> Connecting pin</p> 		<p><b>912 863</b> Glass weight discharge for roof area, for a rebate width of 52 mm, length = 100 mm</p> 

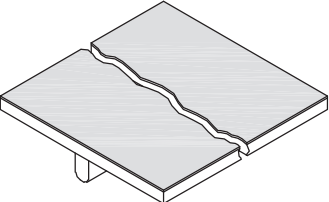
## Connecting pieces with joint sleeves for internal and external corners

Fabricated on request\*

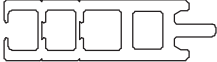
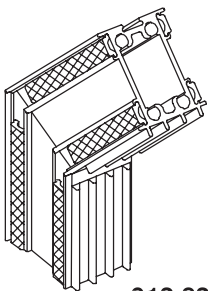

**912 826\***  
Connecting piece 135° for profile 519351 leg length = 150 mm

**912 831\***  
97° to 135°

**912 827\***  
Connecting piece 135° for profile 519352 leg length = 250 mm

**912 832\***  
97° to 135°

**912 828\***  
Connecting piece 135° for profile 519353 leg length = 250 mm

**912 833\***  
97° to 135°

**912 829\***  
Connecting piece 135° for profile 519354 leg length = 300 mm

**912 834\***  
97° to 135°

**912 830\***  
Connecting piece 135° for profile 519354 leg length = 300 mm

**912 835\***  
97° to 135°

\* Not stock item, delivery time must be taken into account.

For easy insertion of EPDM gaskets we recommend the use of lubrication fluid 902 179 (3 litre container).  
Order sealing compound 912 718 as well for gluing EPDM gaskets.

## Positioning and drilling jig, multi-step drill

**912 870**

Transom drilling jig for polygonal connection

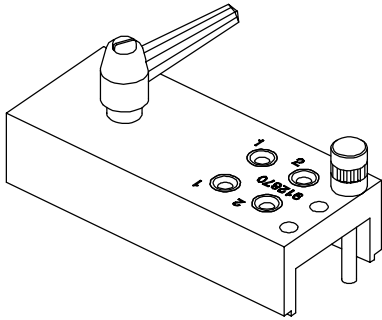

**912 821**

Positioning and drilling jig for polygonal T-bracket connection

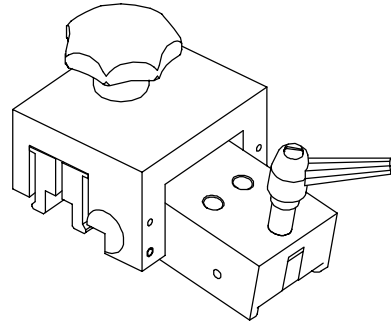

**912 852**

Multi-step drill



**914 202**

Positioning and drilling jig for T-bracket connection, angular

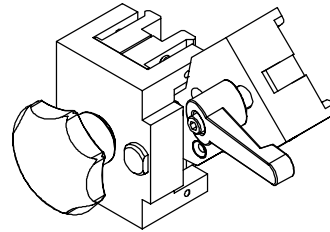

## Glazing bridges / glass supports

**911 809**

Glass support for a rebate width of 16 mm, length = 100 mm

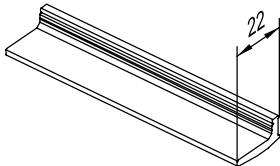

**911 810**

Glass support for a rebate width of 32 mm, length = 100 mm

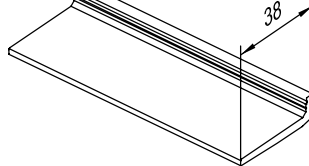

**911 809**

Glass support for a rebate width of 42 mm, length = 100 mm

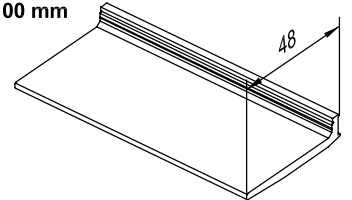

**911 898**

Glass support for a rebate width of 52 mm, length = 100 mm

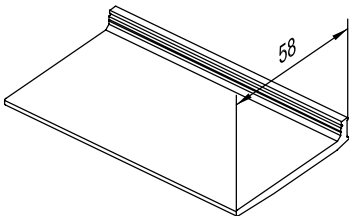

**912 727**

Reinforced glass support for a rebate width of 32 mm, length of 100 mm

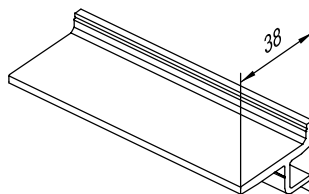

**912 728**

Reinforced glass support for a rebate width of 42 mm, length of 100 mm

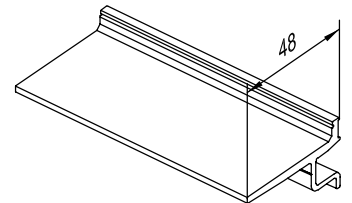

**912 729**

Reinforced glass support for a rebate width of 52 mm, length = 100 mm

